

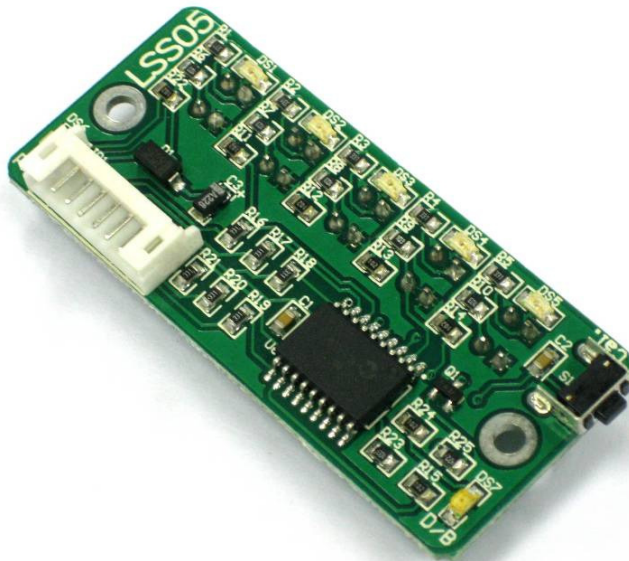

Auto-Calibrating Line Sensor LSS05



User's Manual

V1.2

September 2011

Information contained in this publication regarding device applications and the like is intended through suggestion only and may be superseded by updates. It is your responsibility to ensure that your application meets with your specifications. No representation or warranty is given and no liability is assumed by Cytron Technologies Incorporated with respect to the accuracy or use of such information or infringement of patents or other intellectual property rights arising from such use or otherwise. Use of Cytron Technologies's products as critical components in life support systems is not authorized except with express written approval by Cytron Technologies. No licenses are conveyed, implicitly or otherwise, under any intellectual property rights.

Index

1. Introduction and Overview	3
2. Packing List	4
3. Product Specification and Limitations	5
4. Board or Product Layout	6
5. Installation (hardware)	8
6. Getting Started (from user get the item until using it)	13
7. Warranty (6 months or 1 year)	17

1. INTRODUCTION AND OVERVIEW

LSS05 (Low cost line sensor bar) consists of 5 IR transmitter and IR receiver pairs. LSS05 is typically used for embedded system or robots in line following task. LSS05 can be used for either dark or bright line following. Any color with distinct brightness difference is suitable for LSS05.

The IR transmitters on LSS05 are pulsed to allow the transmitter to off at certain idle period of sensor. This is to minimize the current consumption of LSS05 to at least half of the current consumption compared to a normal unregulated IR line sensor. Power polarity protection is available on LSS05 in case the user accidentally applies a reverse voltage.

LSS05 have 5 digital outputs to user indicating the existence of the line. The threshold to the brightness of line existence will be set when the user calibrate the sensor to the surface that it will recognize. One digital input of calibration signal is available to user for automated calibration function by the user system. User can pull down this signal line with microcontroller to calibrate the sensors. This signal line also can be use to enter different mode of LSS05. Each sensor of the 5 sensors on LSS05 is independent of each other. The refreshing rate of the sensors is more than 100Hz. Every sensor is provided with its own LEDs as indication of line detection.

LSS05 has a manual calibration button. The calibration button is multifunctional. User can enter different mode of functions using calibration button too as the alternative to the calibration signal.

Note: Red color is very bright to IR sensor, thus LSS05 has difficulties in red – white pair color line follow.

2. PACKING LIST

Please check the parts and components according to the packing list. If there is any part missing, please contact us at sales@cytron.com.my immediately.



1. LSS05 PCB with every component soldered properly.
2. LSS05 cable connector

3. PRODUCT SPECIFICATION AND LIMITATIONS

Dimensions

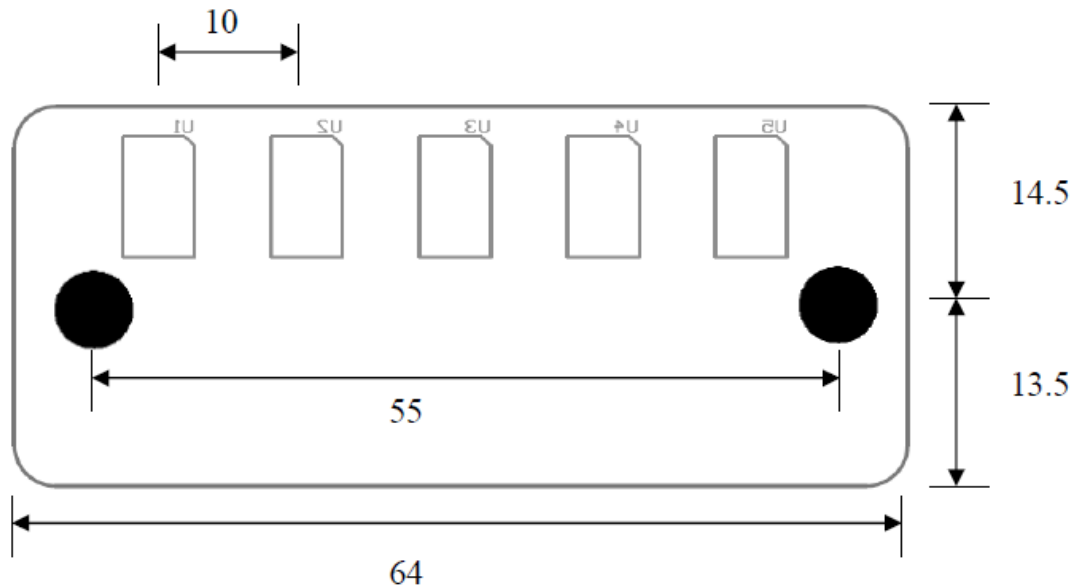

Specifications

Parameter	Min	Typical	Maximum	Unit
IR Emission (peak wavelength)		940		nm
Input signal, V_{IH}	2		5	V
Input signal, V_{IL}	0		0.8	V
Output Signal			5	V

Absolute Maximum Rating

Parameter	Minimum	Typical	Maximum	Unit
Operating voltage			5	V
Maximum Current (I/O signal pins)			20	mA
Sensing distance	1	2	4	cm

4. BOARD OR PRODUCT LAYOUT

Top

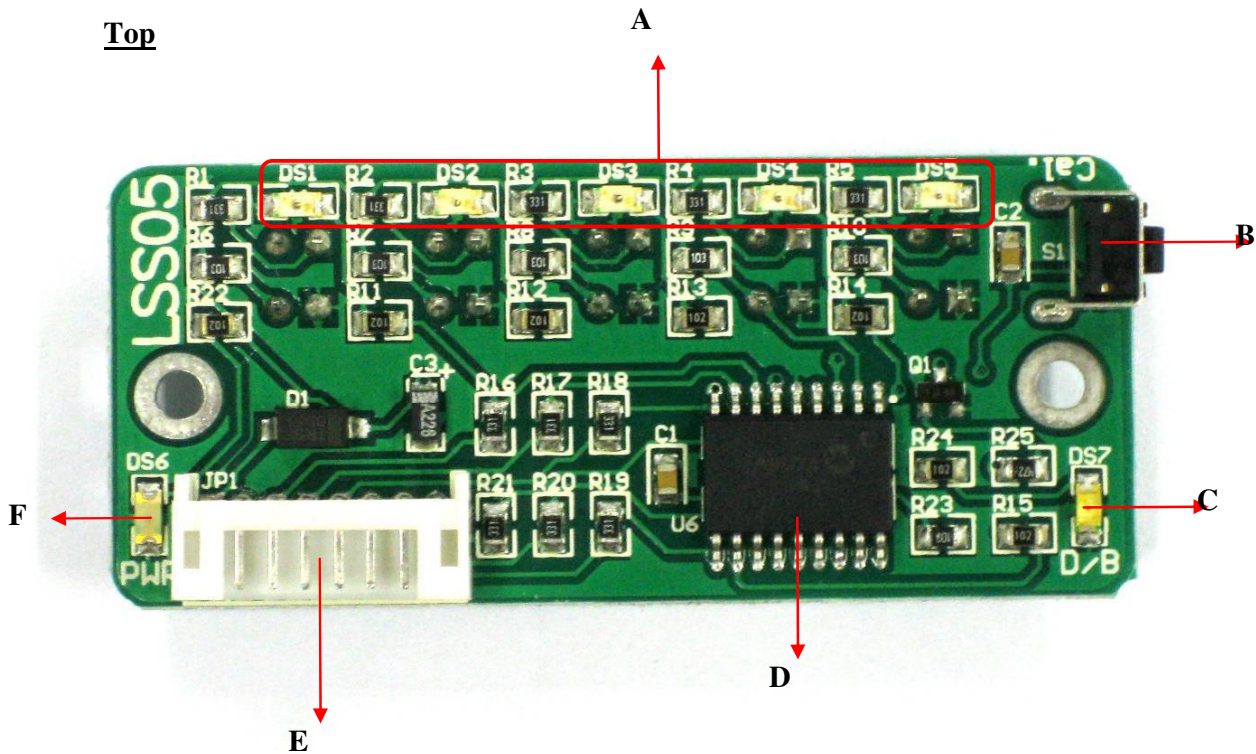

Label	Function	Label	Function
A	Sensor indicator LEDs	D	PIC16F819
B	Calibration button	E	Power and output signal connector
C	Mode indicator LED	F	Power indicator LED

A – Sensor indicator LEDs (red) will light up showing that it detects line.

B – Calibration button is used to enter different modes. Press once to enter the calibration mode. Press twice to set the line sensor bar into dark line following mode and press 3 times to set the line sensor bar into bright line mode.

C – Mode indicator LED (orange) is for indication of the mode. LED will light up if LSS05 is in bright line detection mode. Otherwise, it is off.

D – PIC16F819 PIC microcontroller for data processing.

E – Power and output signal connector

F – Power indicator LED (green) showing the board is supplied with power. Maximum input power is 5V.

Bottom

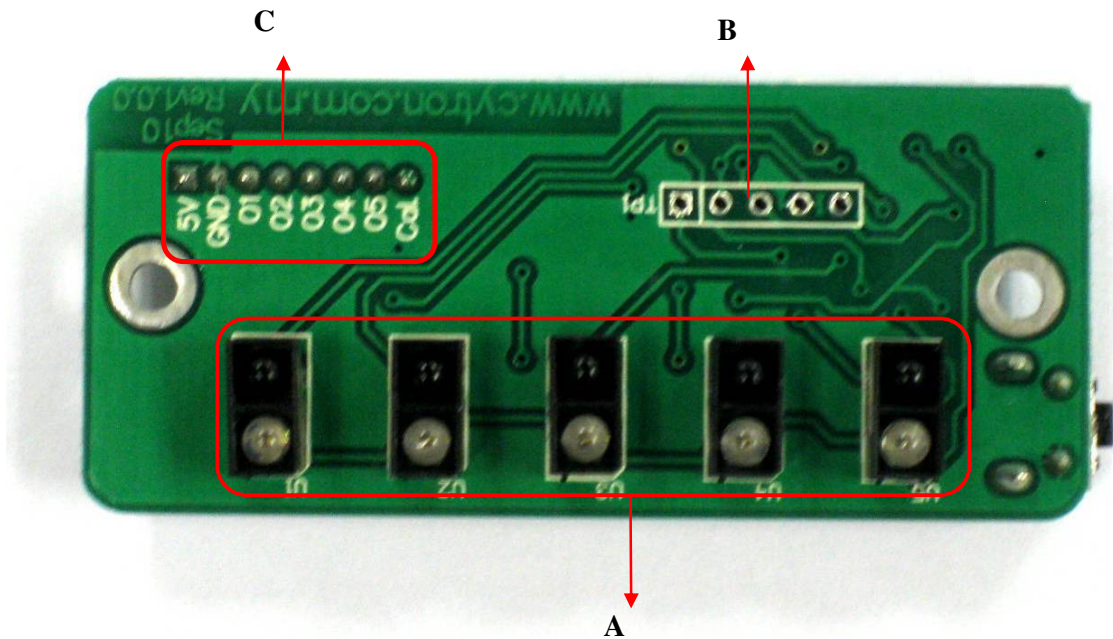

Label	Function
A	Pairs of IR sensor
B	Manufacturing Test Points
C	Input/output signal label

A – Pairs of IR sensor which consist IR transmitter and IR receiver.

B – It is reserved for Manufacturing Test Point. Please **DO NOT** short or connect wire to any of these pins.

C –Input/output signal label showing the Power (5V, GND), output signal pins (O1-O5) and calibration signal (Cal.).

5. INSTALLATION (HARDWARE)

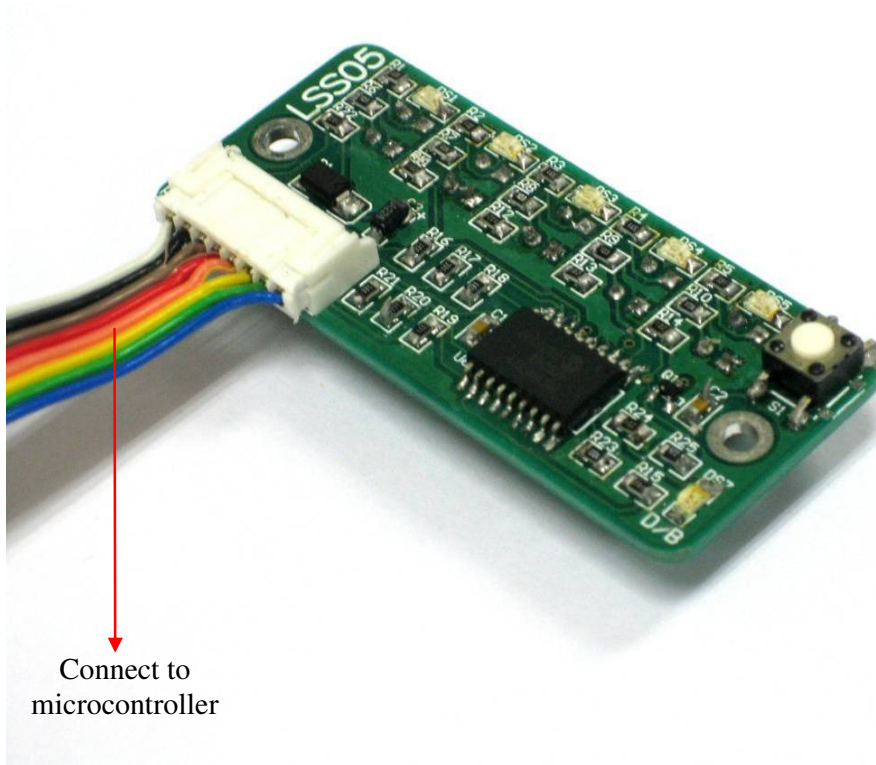

5.1 LSS05 to Mini Mobile Robot Controller (MC40A)

Example application of LSS05 is in MC40A. Used as line detection, LSS05 is usually mounted at the bottom of the mobile robot.

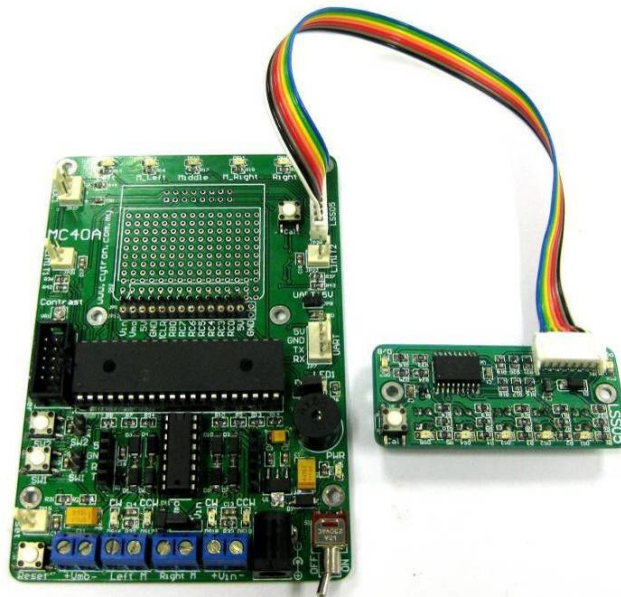

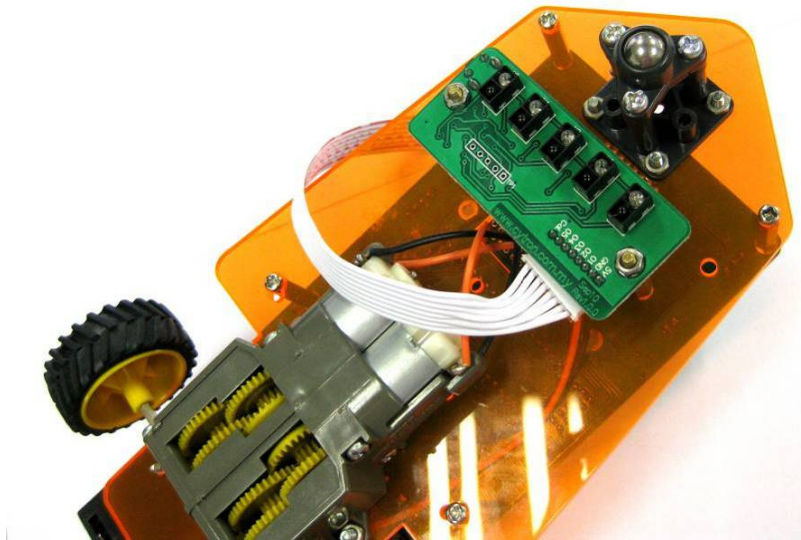

5.1LSS05 cable connector

Figure below shown cable used to connect LSS05 to microcontroller. 2020H-08 connector is used at the end of the cable.



Pin pitch for 2020H connector is not standard size for donut board pin pitch. To use LSS05 with donut board, simply cut the end of connector and solder another type of connector like 2510 or 3960 connector. Following figure is showing the step to connect LSS05 to others type of connector.

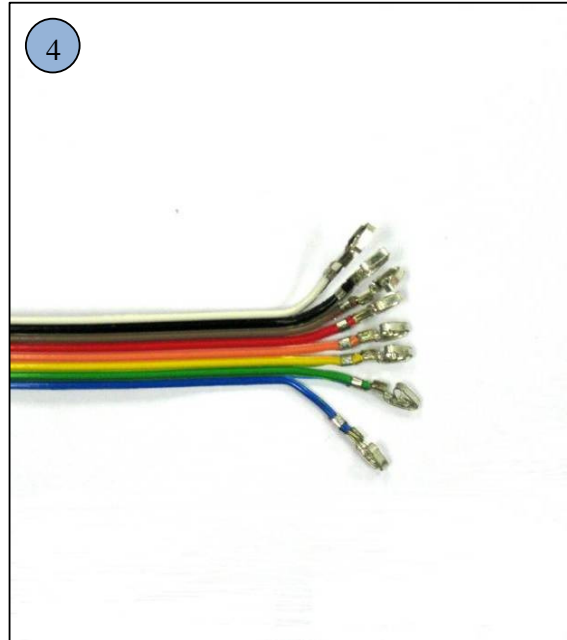
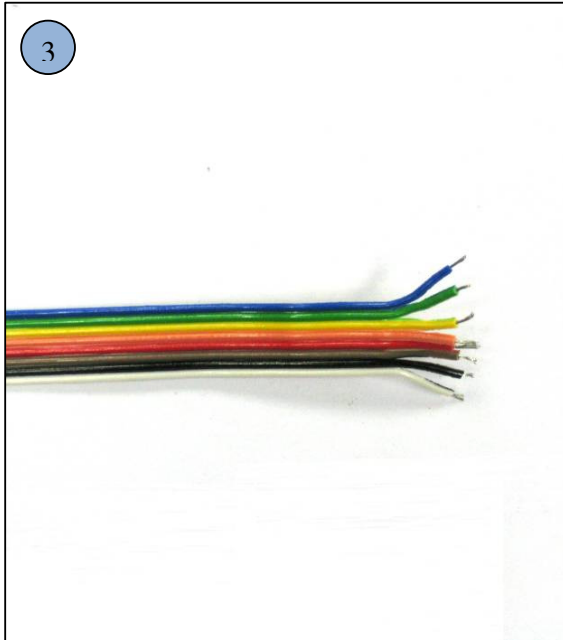
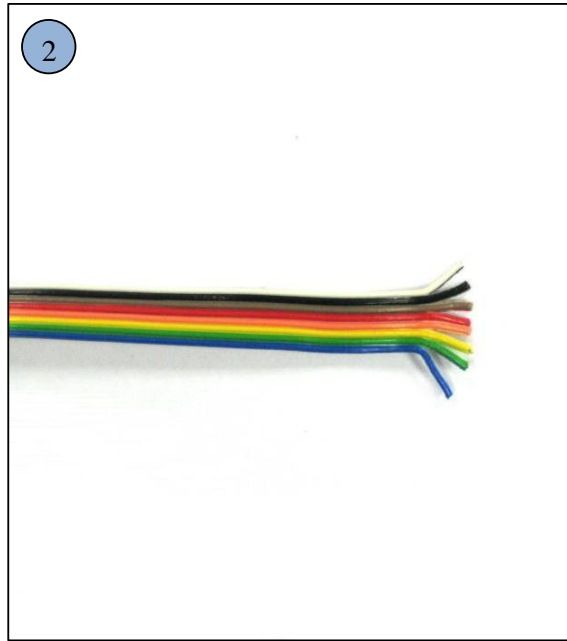
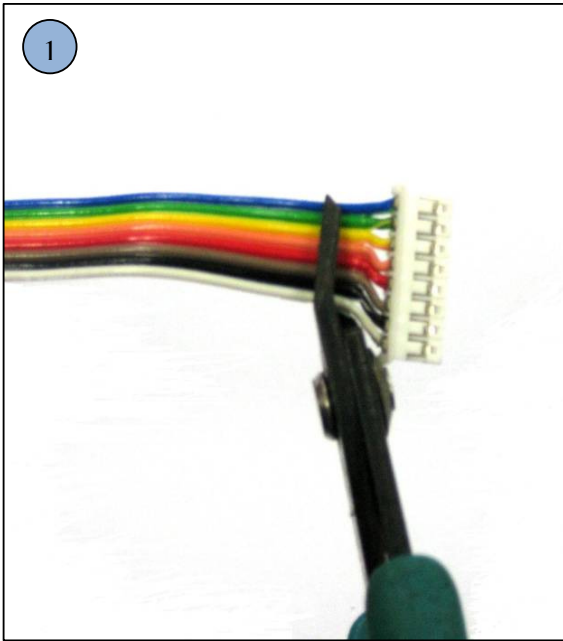

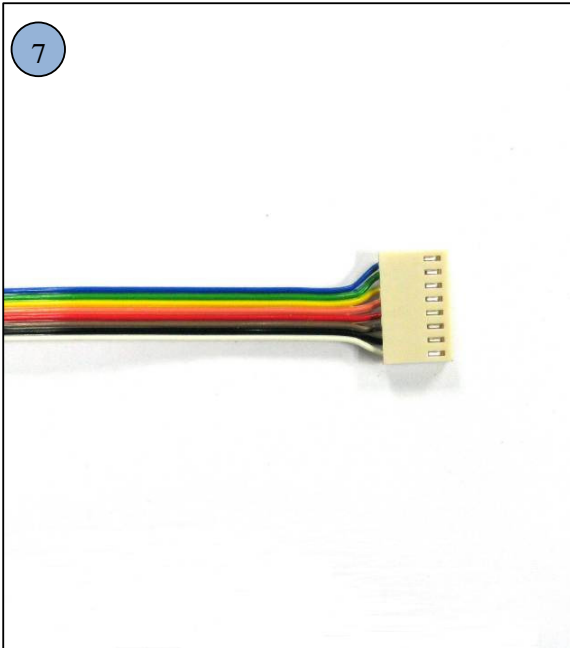
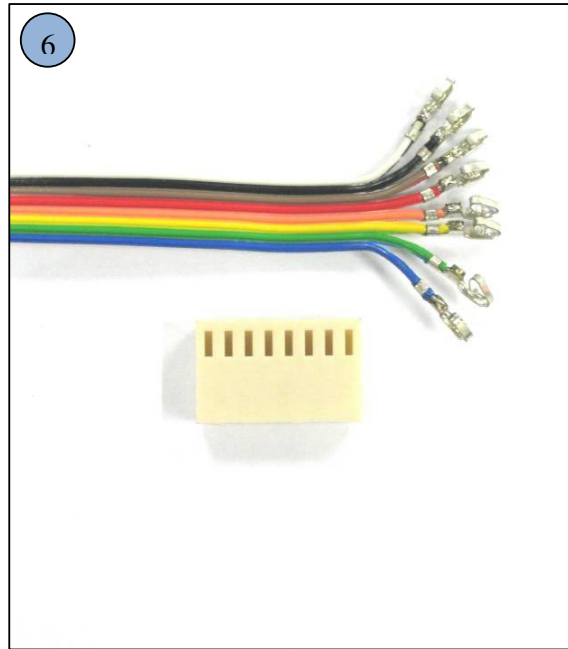
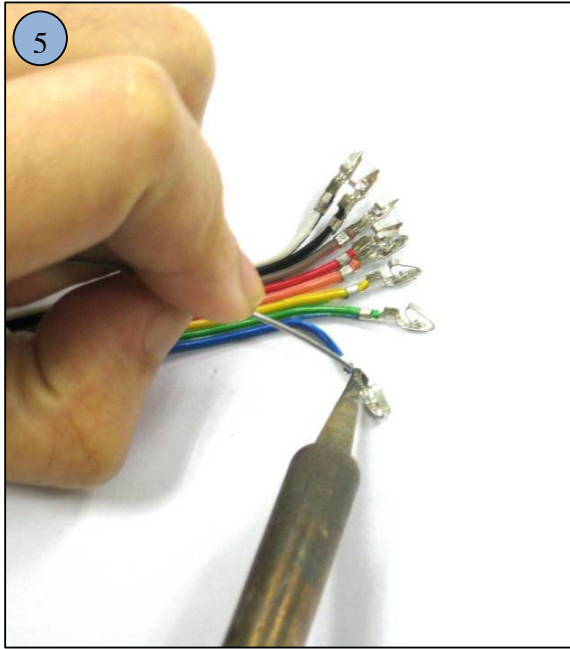
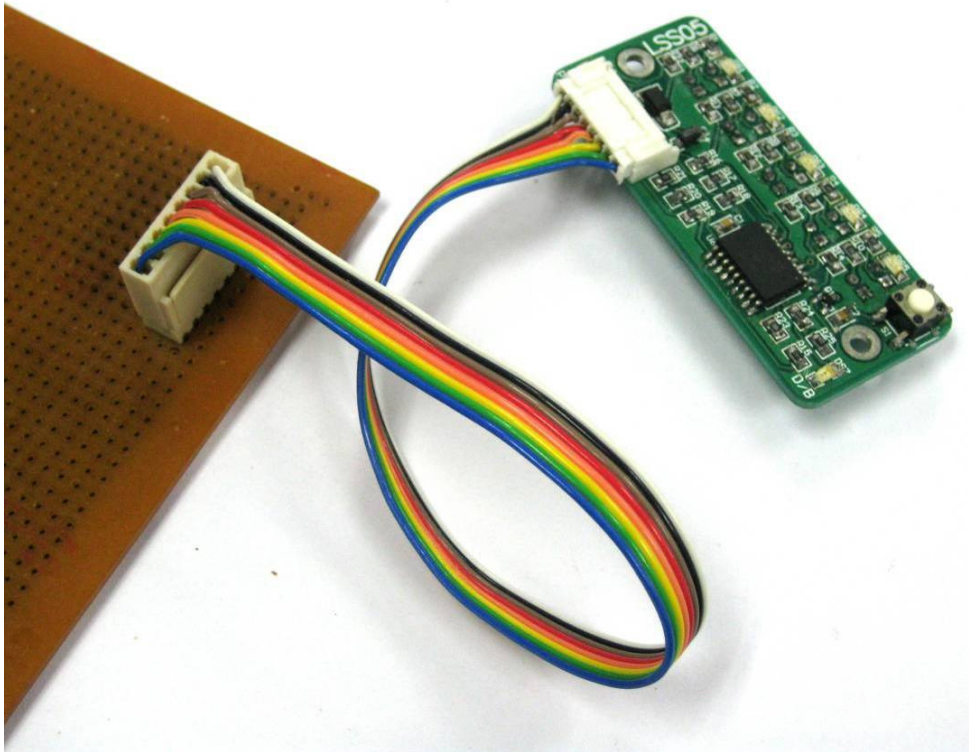
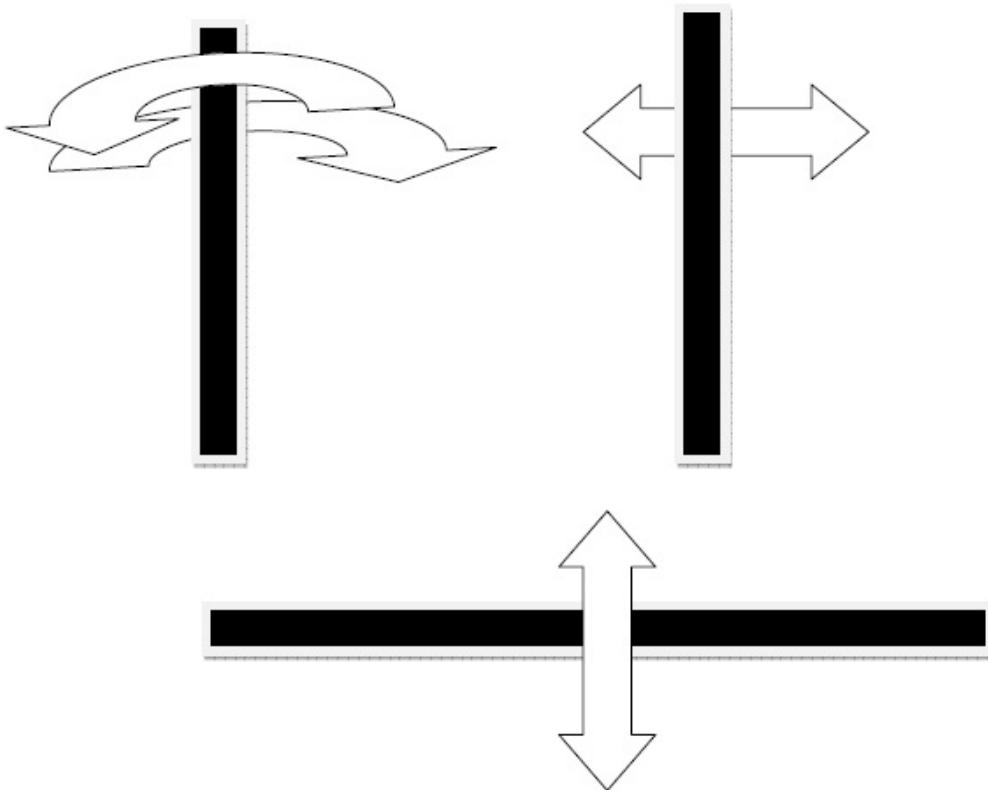

Figure below shown LSS05 was connected to donut board.



6. GETTING STARTED

LSS05 need to be calibrated to retrieve the dark and bright value of the surface that it will do the line follow. **Every** of the IR sensor pairs need to be exposed to the dark and bright surface for it to read the value and save it. LSS05 will save the value in EEPROM, it will retrieve back the data from the EEPROM every time its switch on. Hence, only one time calibration is needed for the same surface and line. To calibrate LSS05, simply press the calibration push button once or pulling down the Cal. for few milliseconds. Calibration will be start by exposing the sensor to the bright surface and then to the dark surface as indicated by the LEDs. 3 LEDs blinking means the bright calibration (2.5 seconds) and 2 LED blinking means the dark calibration (2.5 seconds). Calibration is normally done by crossing every sensor across the line that it will follow as shown in the figure below. Sensors will save the brightest value in the bright calibration process and darkest value in dark calibration. User can calibrate by simply swinging the sensors across the dark and bright surface in order to expose every sensor to the dark and bright surface. Calibration of every sensor is independent and value of each sensor will be saved.



Example motions of calibration by crossing the sensor between the lines.

6.1 Calibration button and signal.

The calibration button or the calibration signal (Cal.) has 2 functions. The 1st function is to call for calibration of the line sensor and the 2nd function is to set whether the sensor bar will operate for dark line following or bright line following.

6.1.1 Using the calibration push button

Press the push button **once** to set the sensor bar into calibration mode. LSS05 will go into calibration mode and the red LEDs will start blinking accordingly to indicate whether it is calibrating for dark color or bright color.

Press the push button twice will set the line sensor into dark line following mode which LSS05 will detect dark line. Sensor indicator LEDs will light up if it detects dark surface (the line is dark) and the output is high. When no dark line is detect, the output will be low.

Press the push button 3 times will set the line sensor bar into bright line following mode which LSS05 will detect bright line; sensor indicator LEDs will light up if it detects bright surface (the line is bright) and the output is high. When no bright line is detect, the output will be low. Dark/Bright indicator (D/B) indicator LED will light up in orange color for this mode.

Below are examples of LSS05 output when it detects dark and bright line. Output 1 is for DS1, output 2 for DS2 and output 3,4, and 5 for DS3,DS4 and DS5 respectively. LED ON means that the sensor detected the line. For example, when sensor1(U1) and sensor2(U2) detected the dark line, DS1 and DS2 will turn ON. The output for sensor1(U1) and sensor2(U2) is high while it is low for sensor which do not detect the line (sensor3(U3), sensor 4(U4) and sensor 5(U5)).

LED					Output				
DS1/U1	DS2/U2	DS3/U3	DS4/U4	DS5/U5	1	2	3	4	5
ON	ON	OFF	OFF	OFF	1	1	0	0	0
OFF	ON	ON	ON	OFF	0	1	1	1	0
OFF	OFF	OFF	ON	ON	0	0	0	1	1
OFF	OFF	OFF	OFF	OFF	0	0	0	0	0

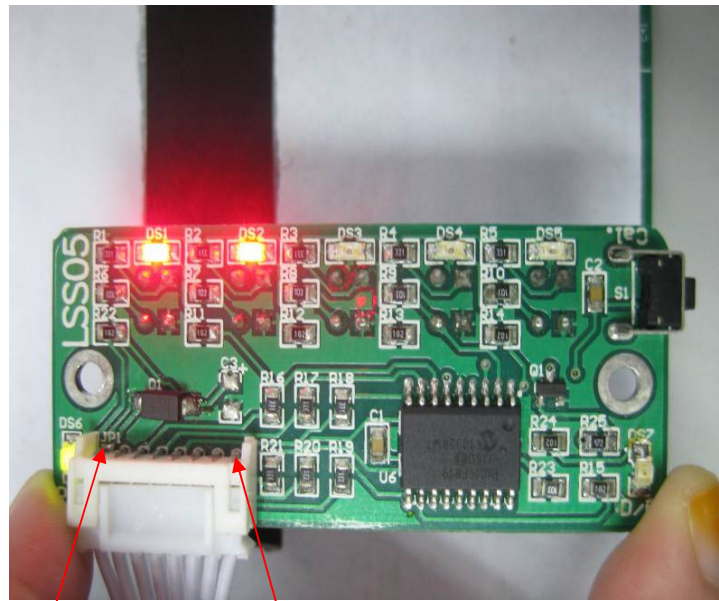

5V GND 01 02 03 04 05 Cal

6.1.2 Using the calibration signal

The calibration signal from the sensor connector can be used to perform exactly the same function as the calibration push button. The calibration signal line requires user to generate falling edges to set for appropriate mode. LSS05 detect how many falling edges to set to appropriate mode.

- One falling edge pulse for calibration mode as shown in figure below. After the falling edge pulse the sensor will start calibration.

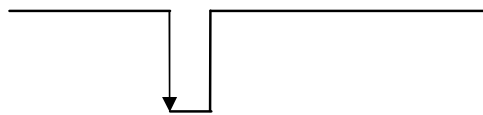

- Two falling edges for setting the LSS05 into dark line mode. The 2 falling edges need to be in range of 1.5 seconds.

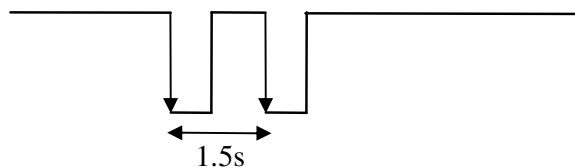

The usage of the calibration signal pin is optional. The pin (TTL, 5V) can be connected to a microcontroller if user want to use it. The Calibration signal pin has the same functions as the Cal button. Instead of manually pushing the Cal button for the settings of LSS05, user can use a microcontroller to pull down the signal to get into the settings. It is similar to the Cal button, pulling down signal pin once set the sensor bar into calibration mode, pulling down the signal pin twice consecutively to set the sensor into dark line mode and pulling down the signal pin 3 times consecutively set the sensor into bright line mode. The timing requirement for the consecutive signals is 1.5 seconds (refer to the timing diagram).

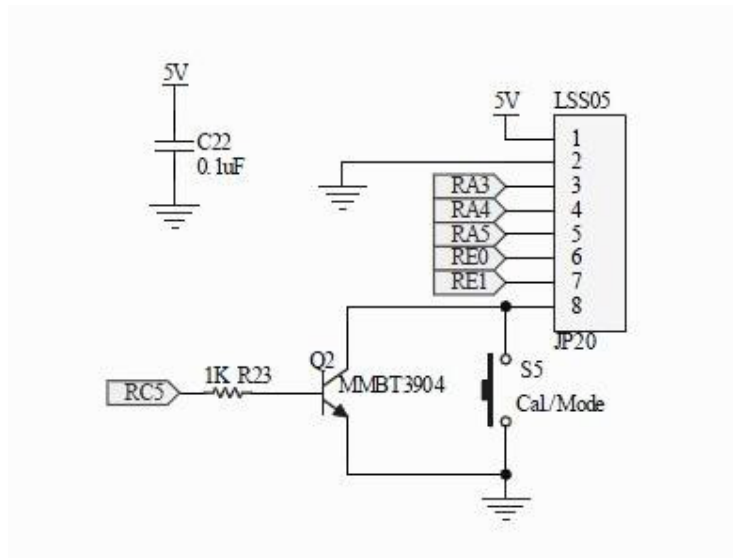

Pin 8 which is Cal signal pin is connected to push button. Then the push button is connect to microcontroller through a transistor.

Reminder: Please keep the Cal. signal at high logic level 5V if it's not generating pulse for the function of the signal.

8. WARRANTY

- Product warranty is valid for 6 months.
- Warranty only applies to manufacturing defect.
- Damage caused by misuse is not covered under warranty.
- Warranty does not cover freight cost for both ways.

Prepared by
Cytron Technologies Sdn. Bhd.
19, Jalan Kebudayaan 1A,
Taman Universiti,
81300 Skudai,
Johor, Malaysia.

Tel: +607-521 3178

Fax: +607-521 1861

URL: www.cytron.com.my
Email: support@cytron.com.my
sales@cytron.com.my