

S2

ROBOT *Start-Up* Guide



Propeller-powered and
fully programmable!

Open-source and
user-hackable!

PARALLAX 

www.parallax.com

S2 Robot (part # 28136) - Please read and retain this instruction booklet.

The S2 robot is not a toy. This product has moving parts and accessible electronic components when the cover is removed. Only enthusiastic or skilled experimenters should partake in S2 customization or hacking activities.

BATTERY SAFETY:

- Only adults should install and replace batteries.
- Do not recharge non-rechargeable batteries.
- Remove dead or exhausted batteries from S2.
- Insert batteries correctly; match positive and negative signs.
- Do not place anything across the battery terminals.
- Use only the size and type of batteries specified in this booklet.
- Do not mix different types of batteries.
- Do not mix old and new batteries.
- Dispose of batteries safely.
- Do not dispose batteries in a fire, they may explode.
- The supply terminals are not to be short-circuited.

This device complies with Part 15 of the FCC rules. Operation is subject to the following two conditions: (1) this device may not cause harmful interference, and (2) this device must accept any interference received, including interference that may cause undesired operation.

Warning: Changes or modifications to this unit not expressly approved by the party responsible for compliance could void the user's authority to operate the equipment.



WARNING: Do not insert any object into sensor holes or any other part of the S2 robot case except as described in this S2 Start-Up Guide. This may damage the unit and will void the warranty.



WARRANTY:

Parallax Inc. warrants its products against defects in materials and workmanship for a period of 90 days from receipt of product. If you discover a defect, Parallax Inc. will, at its option, repair or replace the merchandise. **For assistance contact Parallax: call (916) 624-8333, or toll free in the USA or Canada 888-512-1024, or email support@parallax.com.**

Distributed by Parallax Inc., 599 Menlo Drive, Rocklin CA 95765 USA

Boe-Bot and SumoBot are registered trademarks of Parallax Inc. Parallax, the Parallax logo, Propeller, S2, the S2 logo, and Stingray are trademarks of Parallax Inc. Sharpie is a registered trademark of Sanford, L.P. Copyright © 2010 Parallax Inc. All Rights Reserved. Rev 1.0.

PACKAGE CONTENTS

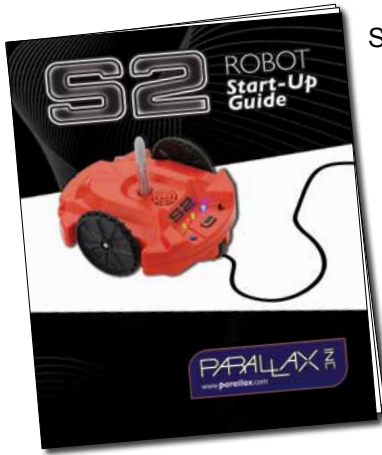

S2 Manual



S2™ Robot

Additional Items Needed (not included)

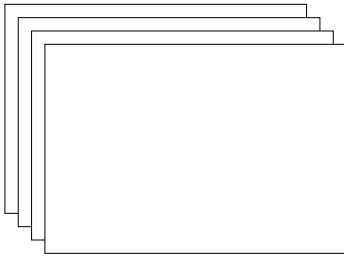

White poster board

Markers - up to ½ inch (12 mm) diameter, such as a Sharpie® fine point.



6 (six) "AA" batteries. 1.5V alkaline, 1.5V standard (carbon-zinc) or 1.2V rechargeable NiMH (nickel-metal-hydride) batteries.



Serial Cable (#800-00003) for programming. If your computer lacks a serial port you would instead need a Parallax USB-to-Serial Adapter and cable (#28031).

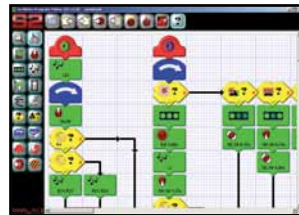

Download the S2 Graphical User Interface for Windows at www.parallax.com/go/s2.

TOP VIEW

infrared emitters

infrared detector

light sensors

pen port

speaker

bi-color indicator
LED lights

power switch

power light

programming port (for serial cable)

reset button

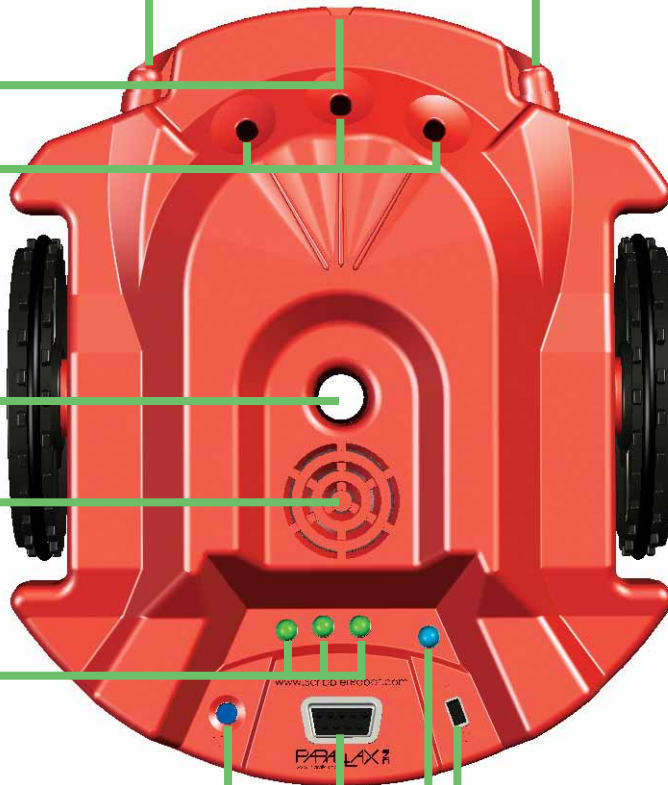

BOTTOM VIEW

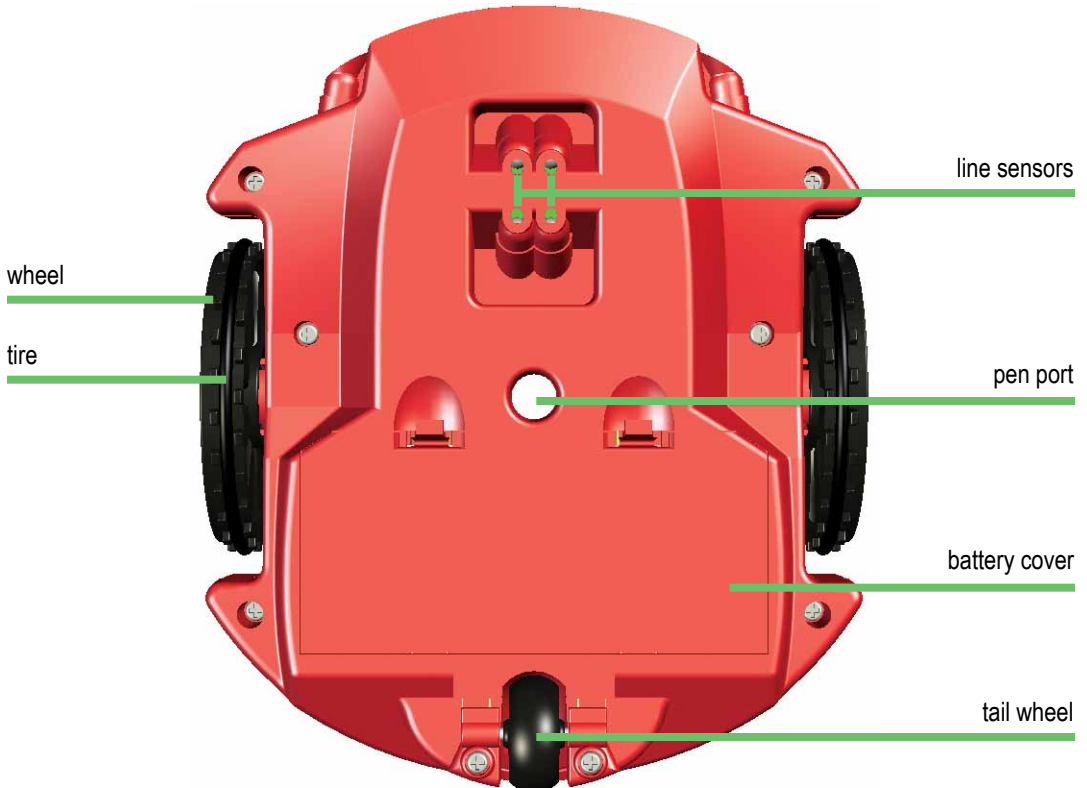

BATTERY INSTALLATION

Step
1



You need 6 (six) “AA” batteries.

You may use 1.5V alkaline, 1.5V standard (carbon-zinc) or 1.2V rechargeable NiMH (nickel-metal-hydride) type batteries.



CAUTION:

- Do not mix different types of batteries.
- Do not mix old batteries with new batteries.
- Do not store the S2 with batteries installed.

Step
2



Put the power switch in the “OFF” position.

“I” = On
“O” = Off

Step
3

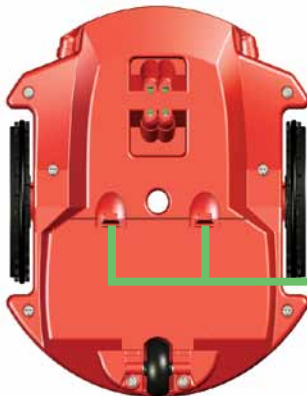

Place the S2 on a towel or other non-scratching surface, bottom side up. Remove the battery cover by pulling the cover latches down toward the tail wheel and then lift the battery cover up.

battery cover latches

Step 4

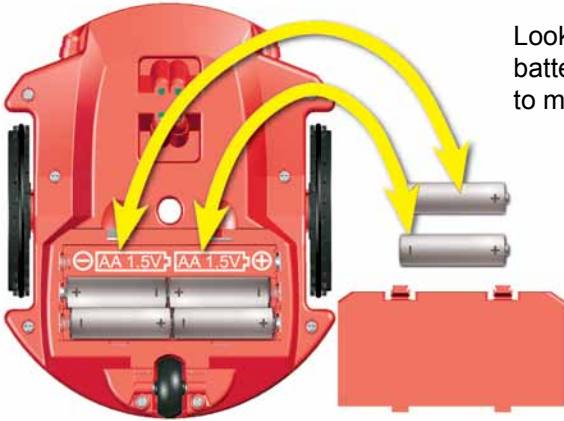

Look for polarity symbols (+/-) in battery compartment. Insert batteries to match up with polarity symbols.

Step 5

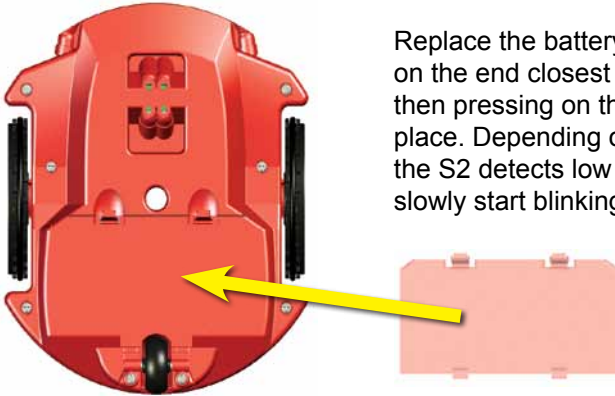

Replace the battery cover by inserting the tabs on the end closest to the tail wheel first and then pressing on the cover until it latches into place. Depending on its programming, when the S2 detects low battery voltages, it will slowly start blinking the blue power light.



OR

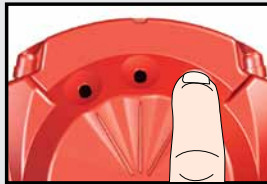

+

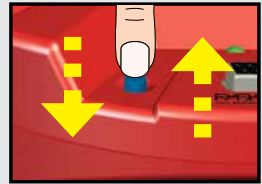

DEMO PROGRAMS: There are 8 Demo play modes. **The Demo play modes can be configured two ways, by pressing the reset button or by using the light sensors.** If you are using the light sensors you will need to be in a brightly lit area to select Demo modes.

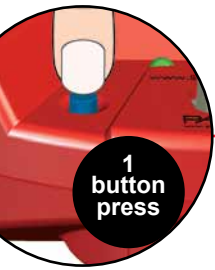

DEMO I: LIGHT SENSORS

light sensors

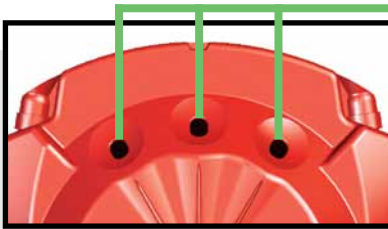

The S2 has 3 light sensors. If you place your finger on a light sensor, the S2 can “see” it because you have blocked out the light shining on the sensor.

Step 1

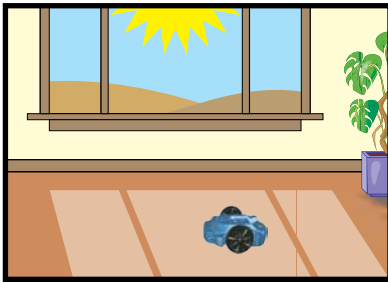

Place your S2 on the floor in a brightly lit room.

Step 2



Put the power switch in the “ON” position.

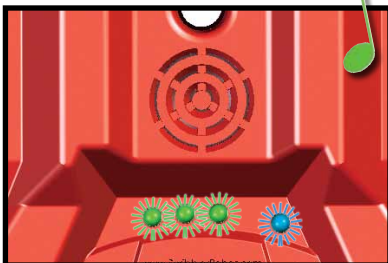

You will hear a song, and all 3 LEDs will light up. The LEDs will be green in a bright room and yellow in a dim room.

Step
3

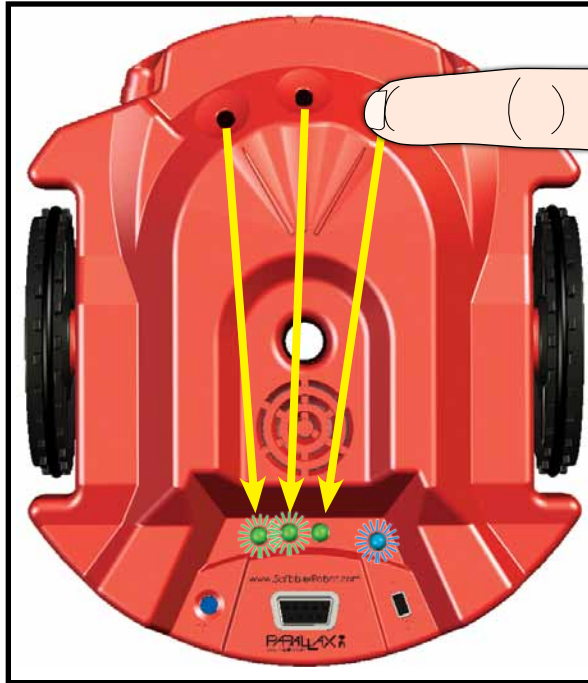

Cover a light sensor hole with your finger. An LED will turn off.

In this demo mode, the left light sensor controls the left LED, the center light sensor controls the center LED, and the right light sensor controls the right LED. Other Demos will use the indicator LEDs in a different way.



Demo 1 is selected each time you turn on the S2, if all the light sensors are uncovered. You can also choose Demo 1 by pressing the reset button with all the light sensors uncovered.

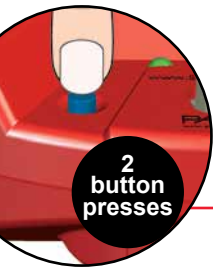

DEMO 2: LIGHT SEEKING BEHAVIOR

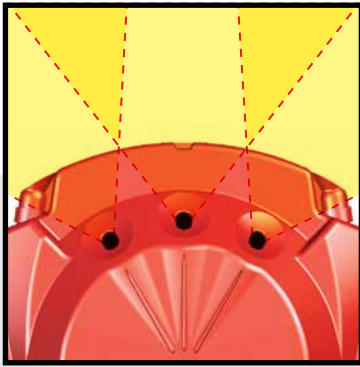

The three light sensors can detect bright light in front of the S2. One sensor looks straight ahead, the other two look 30° to the right and left.

Step
1

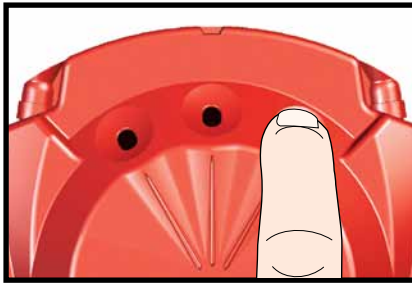

+

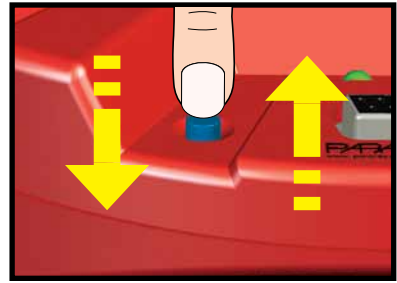

While you cover the right light sensor, press and release the reset button.

Step
2

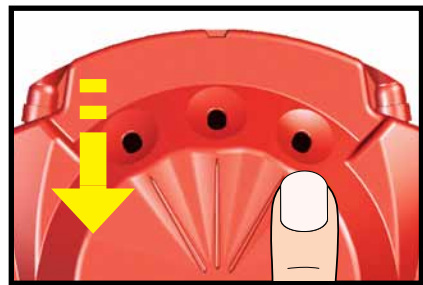
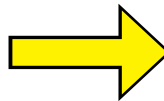

Listen for the beep, then uncover the light sensor.

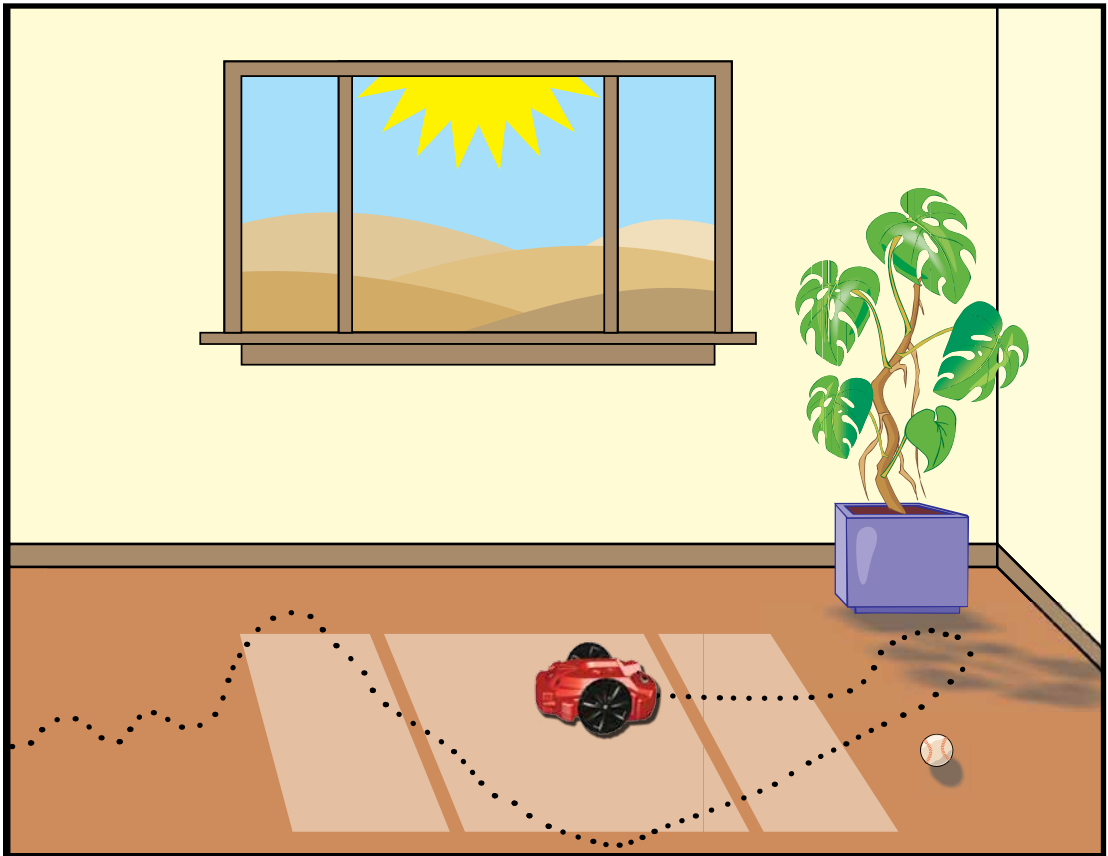

The S2 plays a short song, then drives around the room seeking the brightest light within its view.

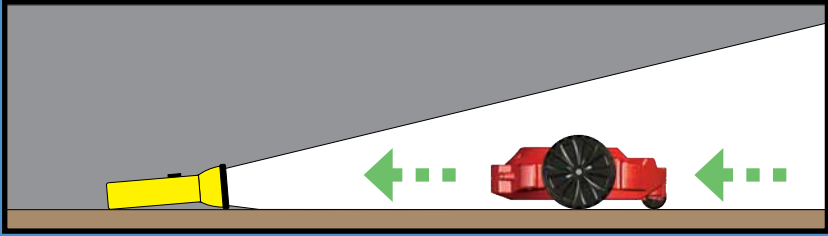

extra

Try this: In a dark room, hold a flashlight at floor level facing the S2. As you move the flashlight around the floor, the S2 will follow it!



DEMO 3: OBJECT DETECTION

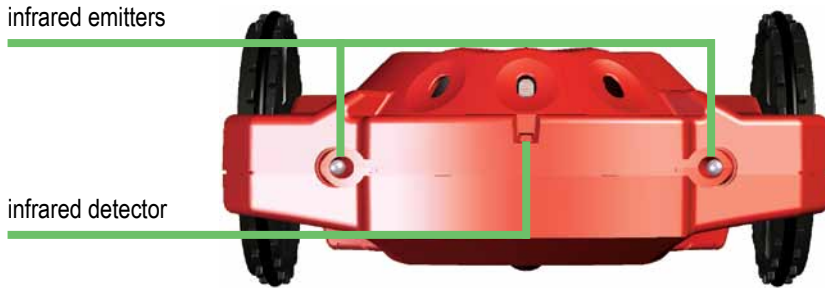

Infrared light shines from the emitters, even though your eyes cannot see it. The S2 can detect the light after it reflects off an obstacle and bounces back to its infrared detector “eye.”

Step 1

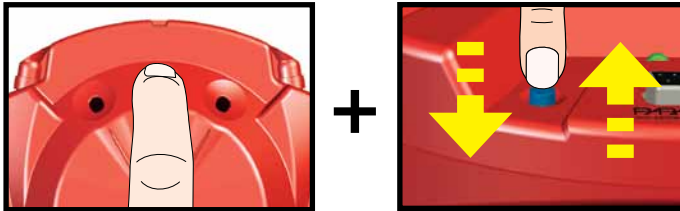

While covering the center light sensor, press and release the reset button.

Step 2

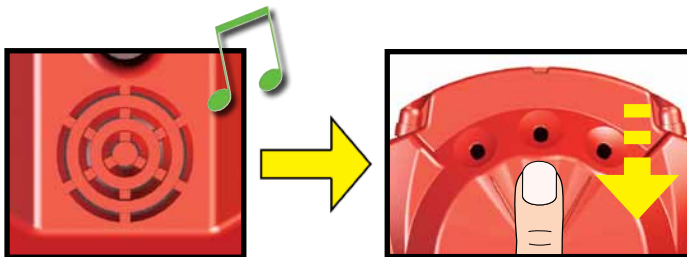

When you hear the beep, uncover the light sensor.

Step
3

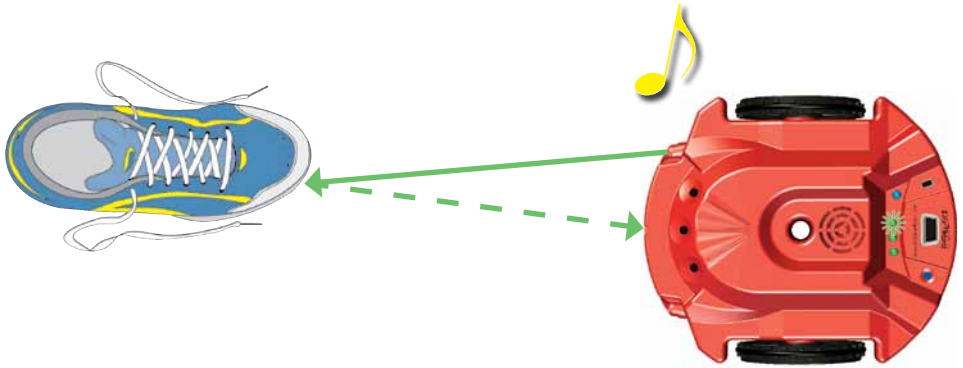

Place an object on the floor in front of the S2. If the S2 sees the object on its right, the right green LED turns on, and the speaker plays a tone. If no object is detected on the right side, the right LED turns red.

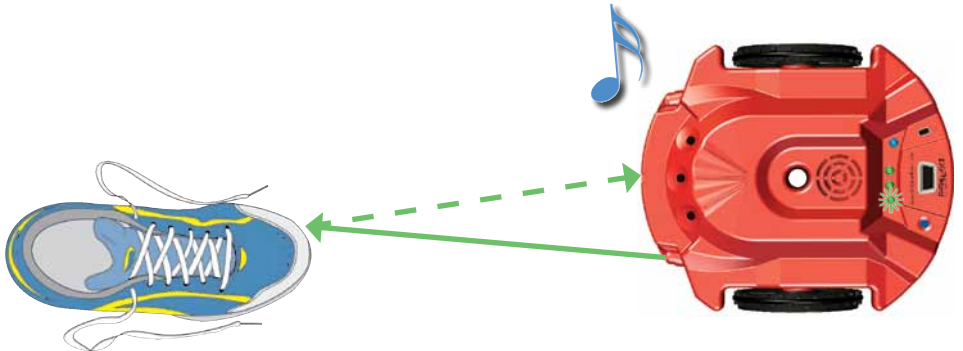

If the S2 sees an object on its left, the left green LED turns on and the speaker plays a different tone. If no object is detected on the left side, the left LED turns red.



If the S2 can see the object with both sensors it will play both tones and both green LEDs will turn on.

The S2 can see light objects better than very dark objects, because dark objects do not reflect much infrared light.



DEMO 4: AVOIDING OBJECTS BEHAVIOR

Step 1

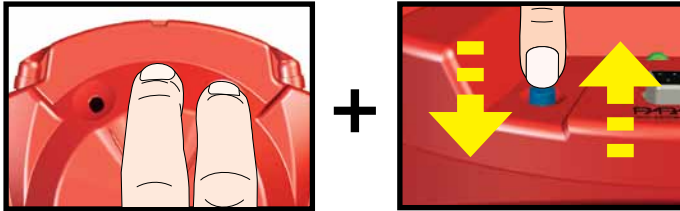

While holding your fingers on the center and right light sensors, press and release the reset button.

Step 2

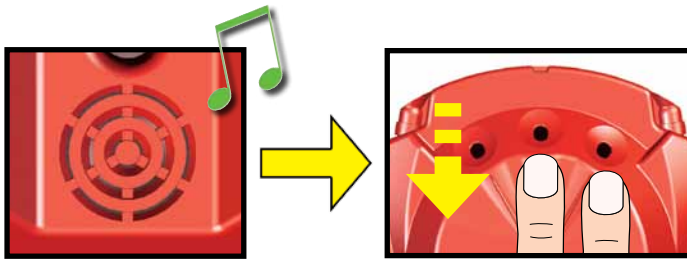

When you hear the beep, uncover the light sensors.

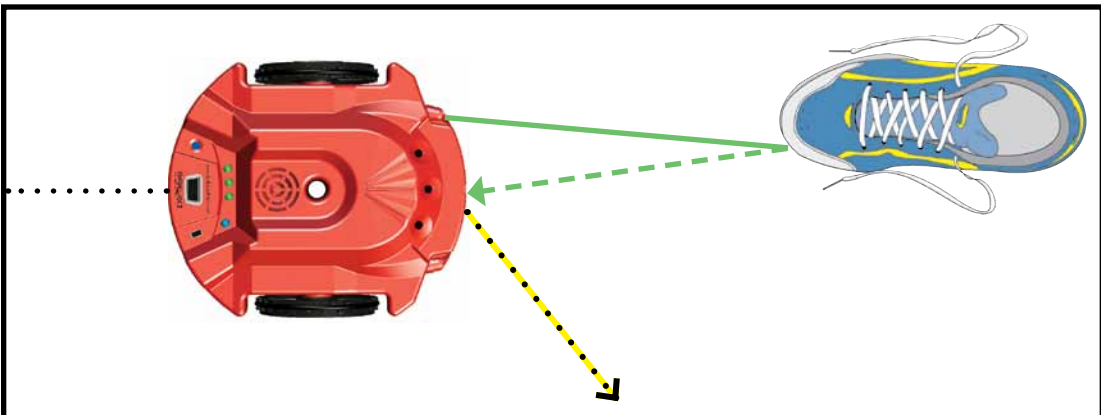

The S2 will drive around the room, turning to avoid objects.

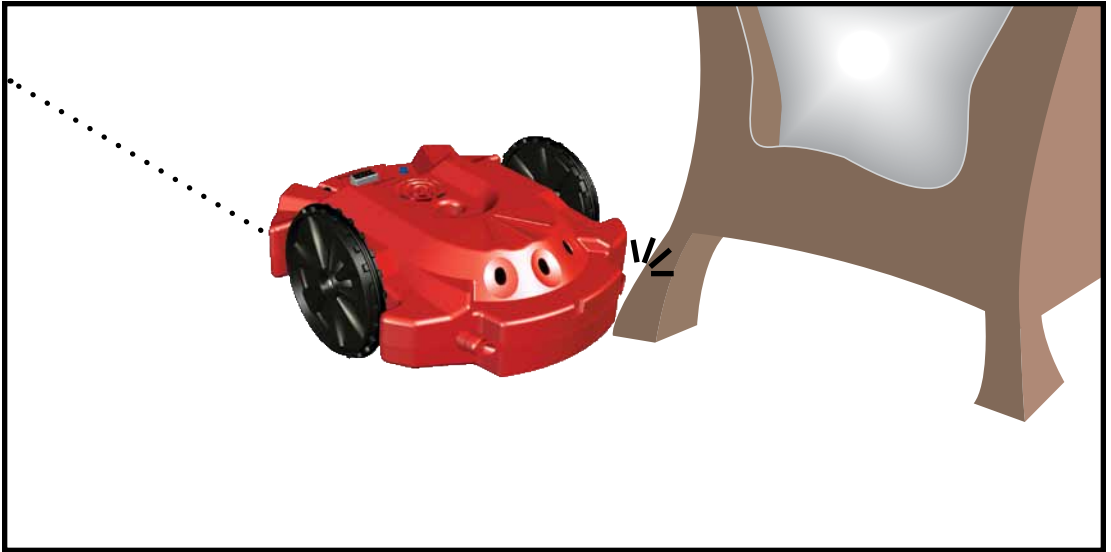

The S2 has a stall sensor inside. If it gets stalled on an object it cannot see...

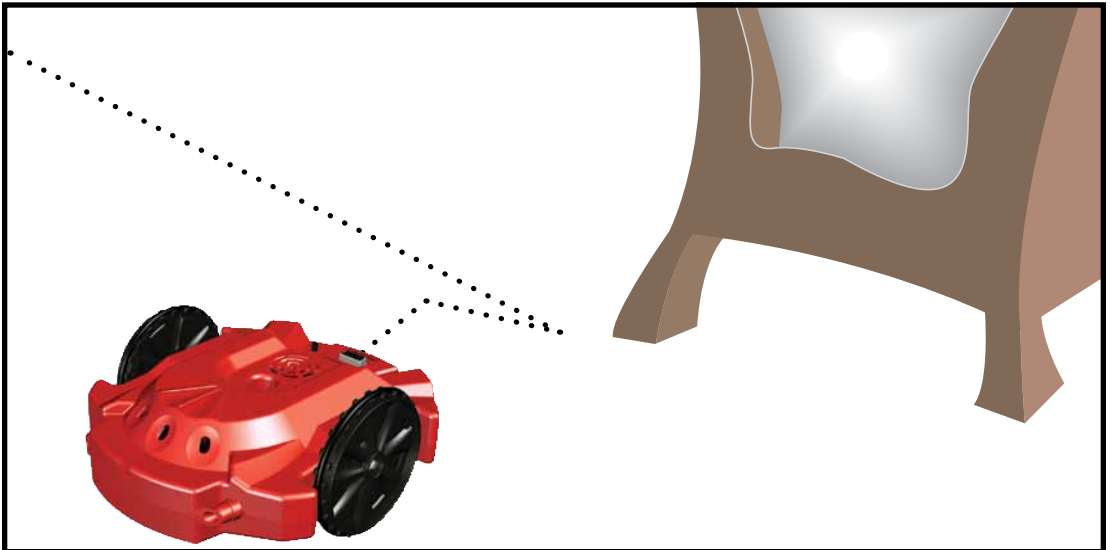

...it will back up, turn, and try driving forward again.

DEMO 5: LINE SENSOR



The S2 has two pairs of infrared emitters and detectors on its underside. With them, it can see a black line on white paper.

Step
1



Print out a set of black lines from the “Tracks.pdf” (Download file from <http://www.parallax.com/go/S2>). For a view of what the printed tracks look like, see page 18 of this booklet.

Do not use photograph printing ink, which reflects infrared light!

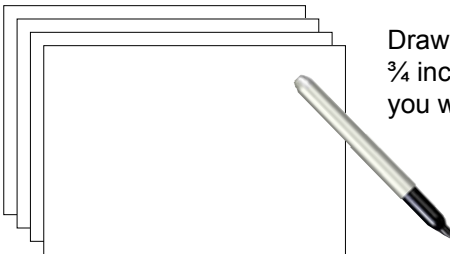

Draw your own tracks by making a black line $\frac{3}{4}$ inch (2 cm) wide, on white paper. To do this you will need:

- white paper
- a black marker

Always protect surfaces with paper or poster board when using a marker or any other writing instrument in your S2. Be aware that some markers can bleed through paper and stain the surface beneath, so test first.

Step
2

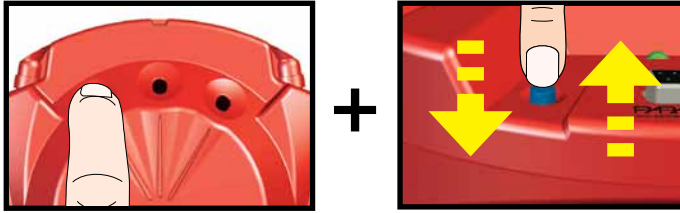

While holding your finger on the left light sensor, press and release the reset button.

Step
3

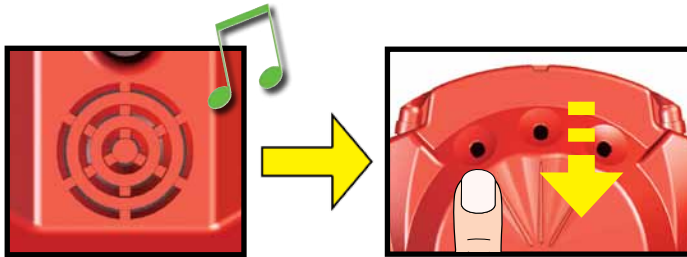

When you hear the beep, uncover the light sensor.

Step
4



Place the S2 on the paper, and move it back and forth across the black line. If the right sensor sees the line, the right green LED will light up. If the left sensor sees the line, the left green LED will light up. If both sensors see the line, both green LEDs light up. The LEDs will be red if no line is detected.

extra The S2 must be resting on the paper to see the line.

Step
3

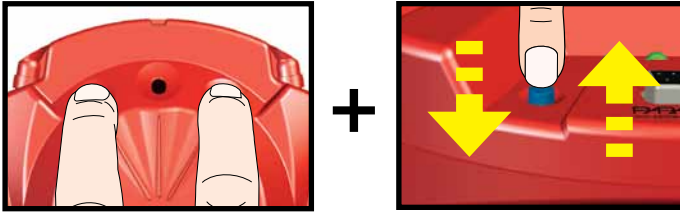

While holding your fingers on the left and right light sensors, press and release the reset button.

Step
4

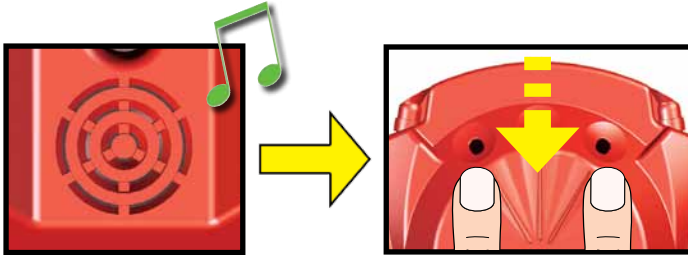

Listen for the beep, then uncover the light sensor.

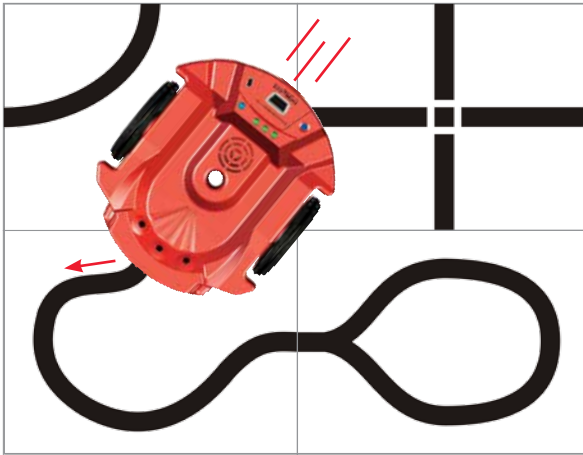

The S2 turns from side to side to find the line, then starts following it. If the S2 loses the line on a tight corner, it will turn back and forth to look for it again.



The S2 does best following black lines about $\frac{1}{4}$ inch (2 cm) wide, on a white background. Line following works best when the track is placed on a hard, level surface. Carpet, tile, or other uneven surfaces may not work well. A dark surface may show through thin paper and make the line harder for the S2 to see.

DEMO 7: SCRIBBLE BEHAVIOR



7
button
presses

Step
1

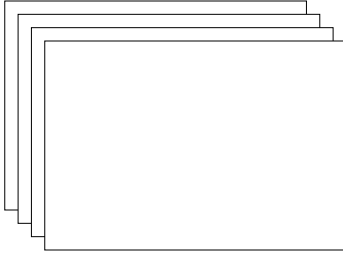

Find:

- white paper or poster board
- a marker

Step
2



Place paper on the floor, and then place S2 on the paper.

Step
3



Place a marker in the pen port. The tip of marker must touch the paper.

Always protect surfaces with paper or poster board when using a marker or any other writing instrument in your S2. Be aware that some markers can bleed through paper and stain the surface beneath, so test first.

Step 4

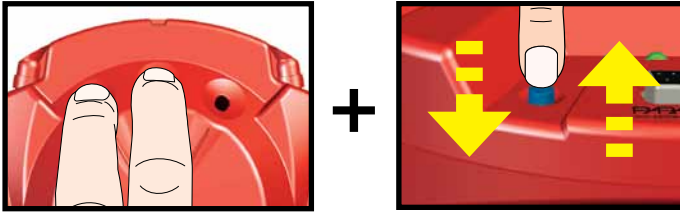

While covering the left and center light sensors, press and release the reset button.

Step 5

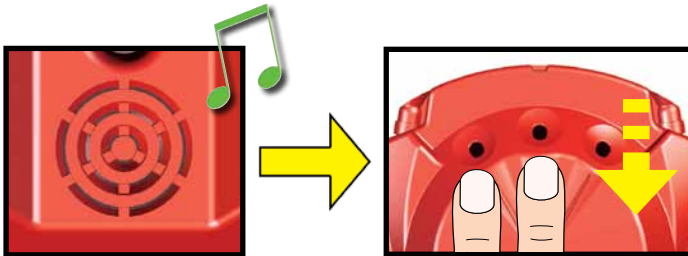

Listen for the beep, then uncover the light sensors.

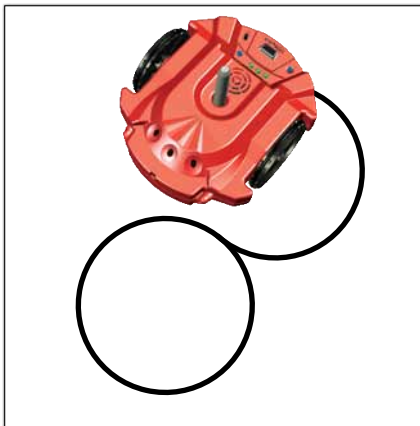

The S2 will draw an approximate figure 8 and then beep.

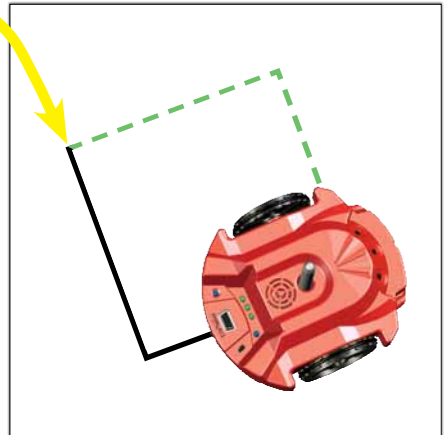

Step 6

Pick up the S2 and put it down on another part of the paper. Then it will draw a box.

DEMO 8: AMBULANCE BEHAVIOR



Step 1

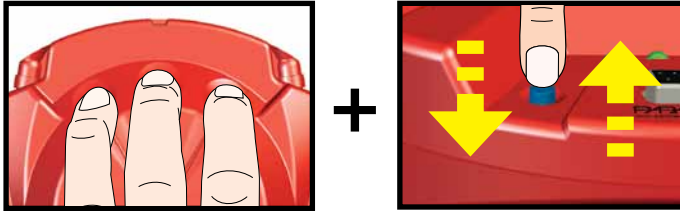

While you cover all 3 light sensors, press and release the reset button.

Step 2

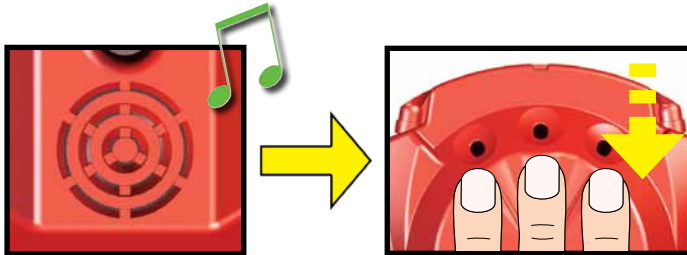

Listen for the beep, then uncover the light sensors.

The S2 drives around blaring its siren and flashing its lights, while avoiding walls and obstacles.

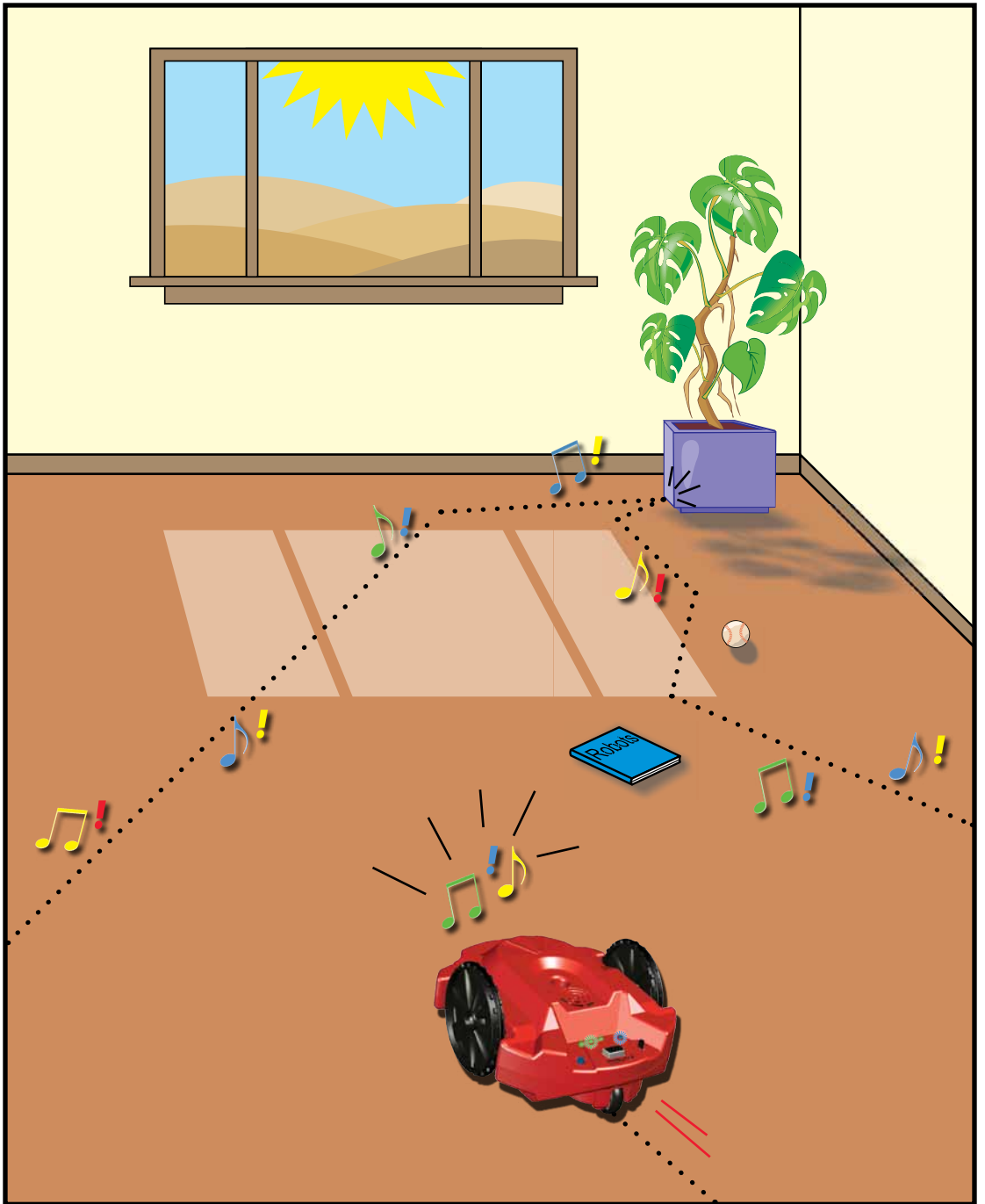

PROGRAMMING YOUR S2 ROBOT

Your S2 robot contains a reprogrammable “brain,” the Parallax Propeller P8X32A-Q44 multi-core microcontroller. This Propeller P8X32A-Q44 chip comes pre-programmed with the 8 Demo modes shown in this guide. You can also write your own custom programs on your PC, and download them to your S2 robot through a programming cable (sold separately, see System Requirements).

Beginners can program in picture blocks with the S2 GUI (Graphical User Interface) programming software. Those interested in learning more about the Propeller and taking full advantage of the many additional possibilities of the S2 robot should download the Propeller Tool code editor from www.parallax.com/go/S2. By programming the S2 directly with the Propeller Tool Code Editor you will have access to the hacker port. The hacker port can be used for RF devices, ultrasonic sensors, passive infrared sensors and anything else you wish to attach or power from your S2 robot. Page 27 includes a variety of helpful S2 resources.

System Requirements:

- PC running Windows® 2000/XP/Vista/7
- Available serial port and serial cable (#800-00003) -OR- USB port with the Parallax USB to Serial Adapter and cable (#28031)
- Printer to print out your tracks for the S2 to follow

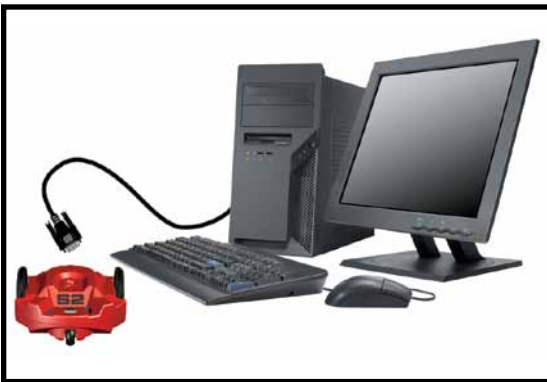

Installation instructions:

- 1) Download and run the S2 GUI from www.parallax.com/go/S2.
- 2) Follow the links and instructions that appear on the screen to install the desired software.
- 3) Connect a programming cable to an available cable port on your computer.
- 4) Connect the other end of the programming cable to the S2 programming port.

Get the most current version of the S2 GUI software at www.parallax.com/go/s2. Here you can also download many example programs that demonstrate the very latest S2 features.

S2 GUI – FOR BEGINNERS

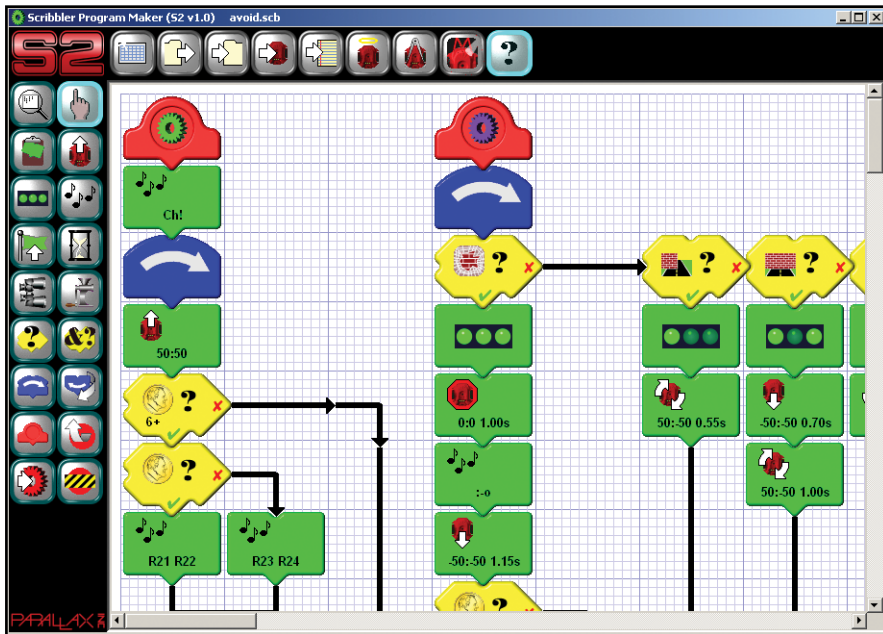

The S2 GUI software lets you build your own programs with picture-coded action “blocks” that turn wheels, blink lights, play sounds, and more. Arrange them in the sequence you want, download the program, and your S2 robot will perform your routine. When you are done, you can press the Restore button on the tool bar to reload the original S2 Demo program.

PROPELLER TOOL CODE EDITOR

The S2's Propeller chip may be programmed directly in the Propeller Tool Code Editor. With the Propeller's multi-processing capability you will have more direct control over the motors, sensors, speaker and lights. Parallax tools support Spin or assembly language under a Windows platform, but other suppliers offer C or PropBASIC on Mac, PC or Linux operating systems. The Propeller Tool Code Editor is used extensively by hobbyists, engineers and students to program the Propeller chip.

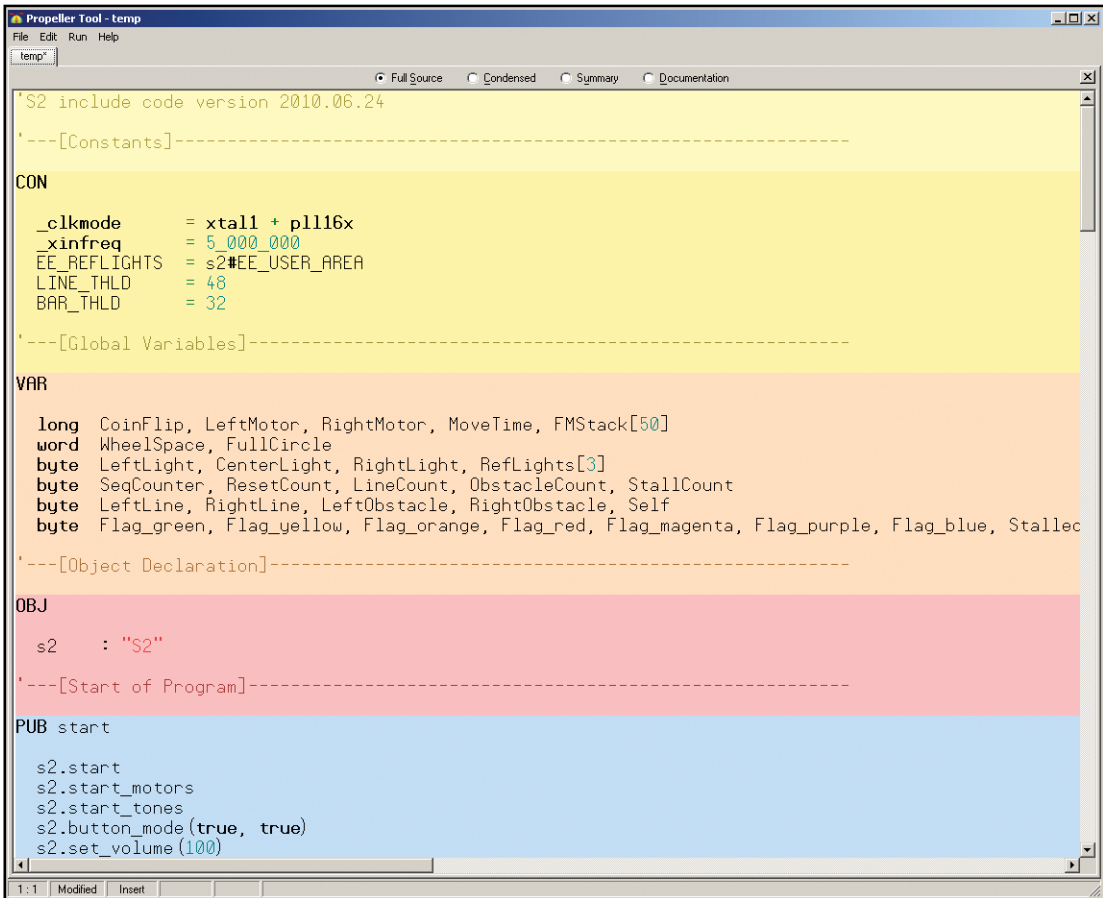

```
Propeller Tool - temp
File Edit Run Help
temp
Full Source Condensed Summary Documentation
'S2 include code version 2010.06.24
'---[Constants]-----
CON
_clkmode      = xtall + pll16x
_xinfreq     = 5_000_000
EE_REFLIGHTS = s2#EE_USER_AREA
LINE_THLD    = 48
BAR_THLD     = 32
'---[Global Variables]-----
VAR
long CoinFlip, LeftMotor, RightMotor, MoveTime, FMStack[50]
word WheelSpace, FullCircle
byte LeftLight, CenterLight, RightLight, RefLights[3]
byte SeqCounter, ResetCount, LineCount, ObstacleCount, StallCount
byte LeftLine, RightLine, LeftObstacle, RightObstacle, Self
byte Flag_green, Flag_yellow, Flag_orange, Flag_red, Flag_magenta, Flag_purple, Flag_blue, Stalled
'---[Object Declaration]-----
OBJ
s2 : "S2"
'---[Start of Program]-----
PUB start
s2.start
s2.start_motors
s2.start_tones
s2.button_mode(true, true)
s2.set_volume(100)
```

You will also want to visit the Parallax Robotics forum at <http://forums.parallax.com>. On this forum you will find 24/7 help from Parallax engineers and customers.

RESOURCES FOR PROPELLER PROGRAMMING

The S2 Robot Start-up Guide will get your S2 rolling, but there's a tremendous amount of customizing that can be accomplished using the many available Propeller programming tools. You can program the S2 on a PC, a Mac, or in Linux using Spin, assembly language, C, or PropBASIC.

SCHEMATICS, DEMOS AND TIPS (<http://www.parallax.com/go/S2>)

Download S2 resources including schematics and hacker port details that you may need to program the S2.



PARALLAX FORUMS (<http://forums.parallax.com>)

Join our Propeller and Robotics forums where 20,000 customers exchange ideas and help.



PARALLAX BOOKS

Many books are available for the Propeller through our online shop at www.parallax.com. Some books which are authored and published by Parallax are also available for FREE download in PDF format.



PARALLAX OPEN-SOURCE INITIATIVE

That's right—the entire S2 design is released under Creative Commons open source license. You have full access to all original design files required to build the S2, including PCB layouts, bill of materials, software source code, and mechanical design. Design files and Creative Commons license details are available at www.parallax.com/go/S2.

HAVE A QUESTION? **NEED TECHNICAL SUPPORT?**

Please contact Parallax directly for help!

Web site: www.parallax.com/go/S2

E-mail: support@parallax.com

Toll free Tech Support in USA or Canada (888) 99-STAMP

Toll free Sales & Information in USA or Canada (888) 512-1024

Our phone number: (916) 624-8333

*Thank you for purchasing the S2 Robot!
We want you to have the best possible robotics experience.*

Learn about the whole family of Parallax Robots
at www.parallax.com/robots

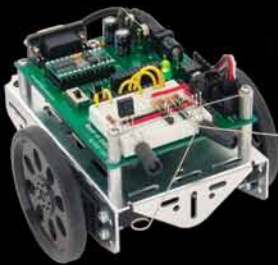

Boe-Bot® Robot
#28132



SumoBot® Robot
#27400

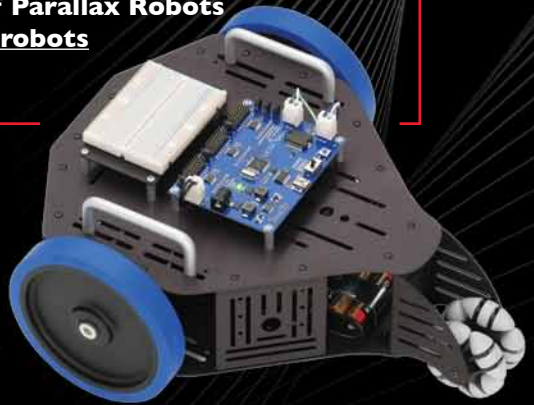

Stingray™ Robot
#28980

NOTE: This equipment has been tested and found to comply with the limits for a class B digital device, pursuant to Part 15 of the FCC Rules. These limits are designed to provide reasonable protection against harmful interference in a residential installation. This equipment generates, uses and can radiate radio frequency energy and, if not installed and used in accordance with the instructions, may cause harmful interference to radio communications. However, there is no guarantee that interference will not occur in a particular installation. If this equipment does cause harmful interference to radio or television reception, which can be determined by turning the equipment off and on, the user is encouraged to try to correct the interference by one or more of the following measures:

- Reorient or relocate the receiving antenna.
- Increase the separation between the equipment and receiver.
- Connect the equipment into an outlet on a circuit different from that to which the receiver is connected.
- Consult the dealer or an experienced radio/TV technician for help.