

Total solder points: 248

Difficulty level: *beginner* 1 □ 2 □ 3 4 □ 5 □ *advanced*

15 Channel infrared receiver

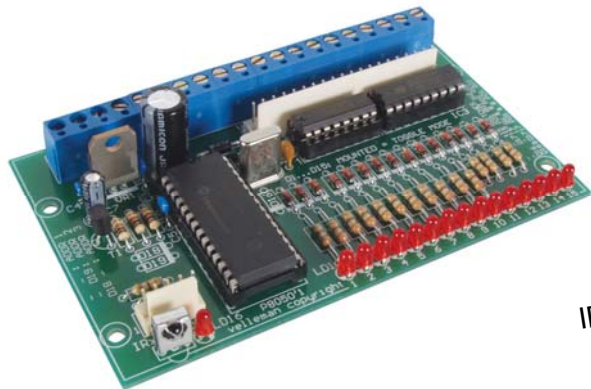

K8050

IR-Remote control transmitters
allow you to control 15 open-
collector contacts

Features:

- Works together with K6710, K8049, K8051, K8055, K8056, K6714 -(16), K2633, ...
- 15 open collector contacts : Max. 50V/50mA.
- LED indication for each output.
- Multiple sensors possible.
- Transmitter - Receiver range : up to 20m
- 4 different modes :
 - 15 independent outputs.
 - 15 rotary outputs
 - 7 independent outputs & 8 rotary outputs.
 - 7 rotary outputs & 8 rotary outputs (independent from each other).
- 3 addressed allow the use of multiple receivers in one room.
- Optional board-to-wire connectors-female (BTWF5 & BTWF20)
- Optional IR-receivers (IR38DM)

Specifications:

- Power supply : 8 –14VDC or 2x6 to 2x12VAC (150mA).
- Current consumption : all outputs off : 10mA
all outputs on : 150mA

1. Assembly (Skipping this can lead to troubles !)

Ok, so we have your attention. These hints will help you to make this project successful. Read them carefully.

1.1 Make sure you have the right tools:

- A good quality soldering iron (25-40W) with a small tip.
- Wipe it often on a wet sponge or cloth, to keep it clean; then apply solder to the tip, to give it a wet look. This is called 'thinning' and will protect the tip, and enables you to make good connections. When solder rolls off the tip, it needs cleaning.
- Thin rosin-core solder. Do not use any flux or grease.
- A diagonal cutter to trim excess wires. To avoid injury when cutting excess leads, hold the lead so they cannot fly towards the eyes.
- Needle nose pliers, for bending leads, or to hold components in place.
- Small blade and Phillips screwdrivers. A basic range is fine.

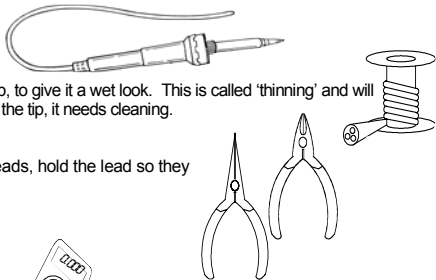

For some projects, a basic multi-meter is required, or might be handy

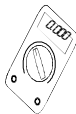
**1.2 Assembly Hints :**

- ⇒ Make sure the skill level matches your experience, to avoid disappointments.
 - ⇒ Follow the instructions carefully. Read and understand the entire step before you perform each operation.
 - ⇒ Perform the assembly in the correct order as stated in this manual
 - ⇒ Position all parts on the PCB (Printed Circuit Board) as shown on the drawings.
 - ⇒ Values on the circuit diagram are subject to changes.
 - ⇒ Values in this assembly guide are correct*
 - ⇒ Use the check-boxes to mark your progress.
 - ⇒ Please read the included information on safety and customer service
- * Typographical inaccuracies excluded. Always look for possible last minute manual updates, indicated as 'NOTE' on a separate leaflet.

1.3 Soldering Hints :

1- Mount the component against the PCB surface and carefully solder the leads

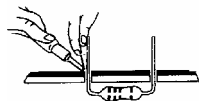

2- Make sure the solder joints are cone-shaped and shiny

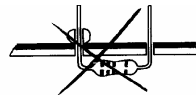
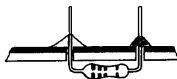

3- Trim excess leads as close as possible to the solder joint



REMOVE THEM FROM THE TAPE ONE AT A TIME !

AXIAL COMPONENTS ARE TAPED IN THE CORRECT MOUNTING SEQUENCE !

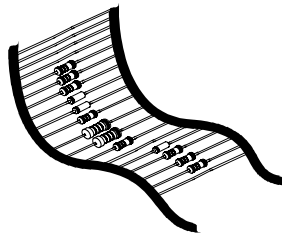

1. Diodes, check the polarity

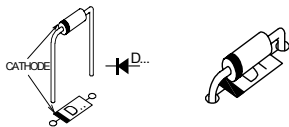

- D20 : 1N4007
- D21 : 1N4007

👉 **Remark:** D1 to D19 are not mounted at this time.

- R8 : 390 (3-9-1-B)
- R9 : 390 (3-9-1-B)
- R10 : 390 (3-9-1-B)
- R11 : 390 (3-9-1-B)
- R12 : 390 (3-9-1-B)
- R13 : 390 (3-9-1-B)
- R14 : 390 (3-9-1-B)
- R15 : 390 (3-9-1-B)
- R16 : 390 (3-9-1-B)
- R17 : 10K (1-0-2-B)
- R18 : 10K (1-0-2-B)
- R19 : 10K (1-0-2-B)
- R20 : 10K (1-0-2-B)

2. Resistors

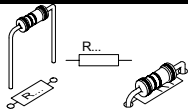

- R1 : 390 (3-9-1-B)
- R2 : 390 (3-9-1-B)
- R3 : 390 (3-9-1-B)
- R4 : 390 (3-9-1-B)
- R5 : 390 (3-9-1-B)
- R6 : 390 (3-9-1-B)
- R7 : 390 (3-9-1-B)

3. IC's.

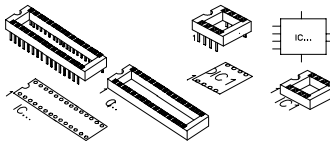

- IC1 : 28p
- IC2 : 16p
- IC3 : 18p

4. Ceramic Capacitors

- C1 : 18pF (18)
- C2 : 18pF (18)
- C3 : 100nF (104, u1)
- C4 : 100nF (104, u1)
- C5 : 100nF (104, u1)
- C6 : 100nF (104, u1)

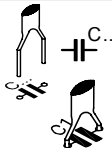

5. LED's. Watch the polarity!

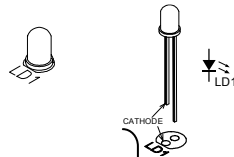

- LD1
 - LD2
 - LD3
 - LD4
 - LD5
 - LD6
 - LD7
 - LD8
 - LD9
 - LD10
 - LD11
 - LD12
 - LD13
 - LD14
 - LD15
 - LD16
- } 3mm Red

6. Transistor

T1 : BC547B

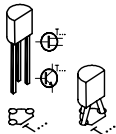
7. Electrolytic capacitor.
Watch the polarity !

C7 : 10 μ F

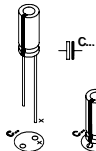

8. IR- Receiver

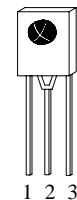

IRX1

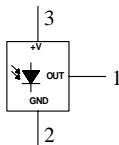

9. Headers

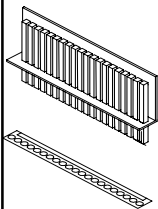

- SK11 : 5p
- SK12 : 20p

10. Terminal blocks

- SK1
- SK2
- SK3
- SK4
- SK5
- SK6
- SK7
- SK8
- SK9
- SK10

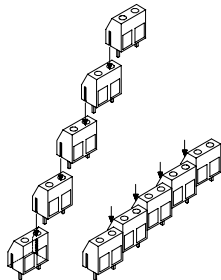

11. Quartz crystal

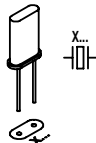

X1 : 4MHz

12. Voltage regulator

□ VR1 : UA7805

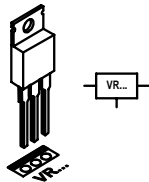

13. Electrolytic capacitor. Watch the polarity !

□ C8 : 1000 μ F/25V

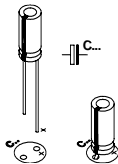

14. IC's. Watch the position of the notch!

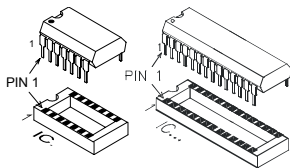

- IC1 : VK8050
Programmed PIC16C55A-04 or equal !
- IC2 : ULN2003 or eq.
- IC3 : ULN2803 or eq.

15. set - up

The K8050 features 4 operating modes, selectable with diodes D16 and D17.

- 1) 15 independent outputs.
- 2) 15 rotary outputs
- 3) 7 independent outputs & 8 rotary outputs.
- 4) 7 rotary outputs & 8 rotary outputs (independent from each other).

MODE	D16	D17
1	Not mounted	Not mounted
2	Not mounted	Mounted
3	Mounted	Not mounted
4	Mounted	Mounted

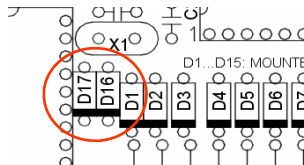

Momentary (push button-) function : Hold the key to activate the output and release the key to deactivate it.

Toggle function : Operates according to the principle of a classic switch, i.e. you have to press the key once to switch and press again to deactivate it.

For each output :

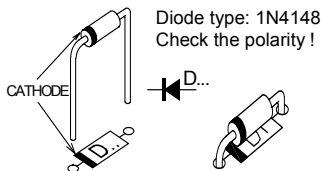

- If a **momentary** output is needed, DO **NOT** mount a diode for the corresponding output D1 to D15.
- If a **toggle** output is needed, **MOUNT** a diode for the corresponding output D1 to D15.

ADDRESS SELECTION

Different possibilities in conjunction with diode setup:

The address selection allows you to operate up to 3 receivers in the same room without interference. Each receiver shall have its own address setting.

HINT: 3 receivers in the same room gives you 45 outputs thanks to address setting.

D18	D19	ADDRESS SELECTION
Not mounted	Not mounted	1 (D4 K6710)*
Not mounted	Mounted	2 (D6 K6710)*
Mounted	Not mounted	3 (D5 K6710)*

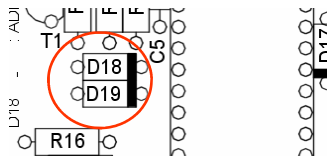

👉 **ATTENTION:** the receivers can only be operated by a transmitter allowing address setting. For the setting of the transmitter, we refer to the manuals of the kits in question.

* **K6710 :**

To make the transmitter K6710 work with the receiver K8050, the identification of the transmitter must be adjusted to that of the receiver:

Address 1: mount diode D4

Address 2: mount diode D6

Address 3: mount diode D5

SEVERAL IR RECEIVERS

If you wish to connect more than one receiver to your system, they should be connected in parallel (see below fig 1.0). To preserve the transmission quality it's advisable to use twin - shielded cable (Ordernr. : PUC2025).

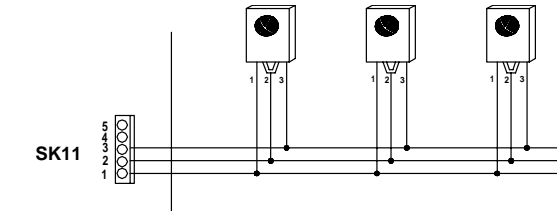
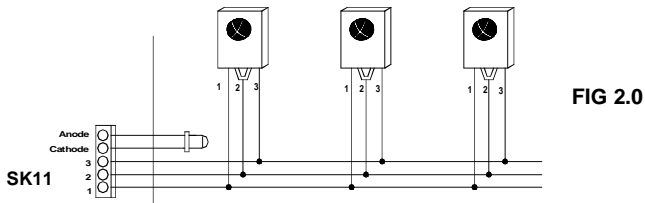

FIG 1.0

If you want to mount the reception indication LED at a distance (cf. fig. 2.0), do not mount LD16 directly on the circuit board, but connect it to the board by means of a cable of the desired length.



USING SEVERAL RECEIVER INDICATIONS

In case you want for each receiver a diagnostic LED, connect them parallel and each LED in series with a resistor (390Ω).

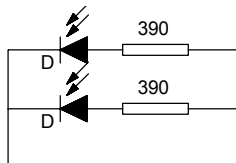

16. Testing the circuit

Connect 2x6 to 2x12VAC or 8 to 14VDC / 150mA (see pag13).

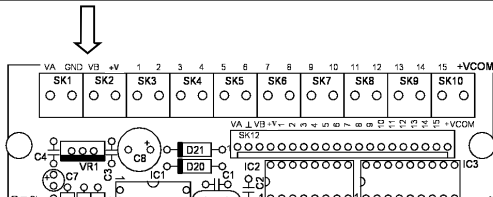

Before making a final connection we will test the circuit :

Use a 2x6 to 2x12VAC power supply to feed the receiver or connect an 8 to 14VDC power supply between the points GND and VA or VB (Fig 2.0).

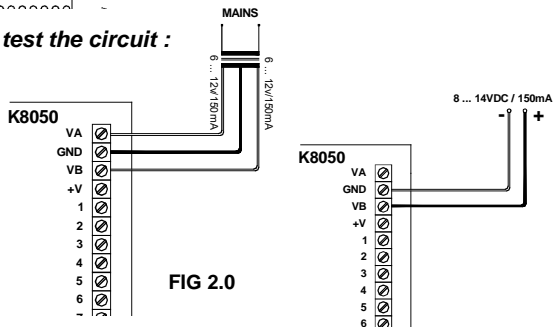

Now test the inputs :

Using your transmitter, choose each time a different output.
 Ex. Press 1 on your transmitter, normally LED LD1 should light.
 Repeat this for every output.
 All the LED's should have lit up one by one.

Test the outputs :

You can check each output for correct operation, using a LED and resistor (390Ω) in series.
 Connect pin +V of SK2, see point A with the left side of the resistor (See fig 3.0) and connect the cathode side of the diode with the output 1. The right side of the resistor is connected with the Anode of the LED.
 Repeat this for every output (A+2, A+3, ... A+15).
 The LED should have lit each time you have chosen a different output.

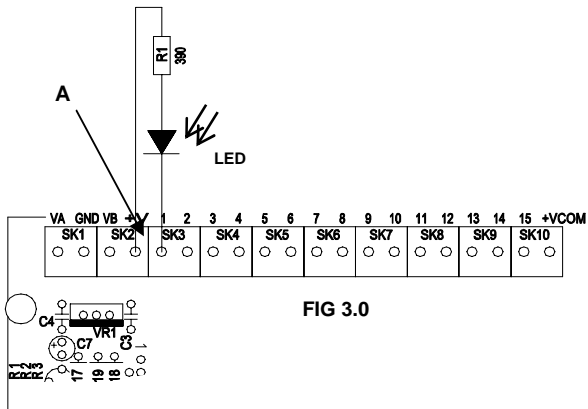
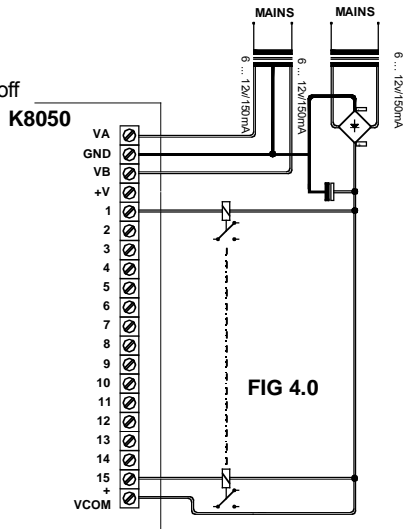

FIG 3.0

17. Usage and connection

Usually the open-collector outputs are used for controlling relays (like our card K6714, Fig 5.0).

Figure 4.0 shows how to connect eventual relays. Its advisable to use a separate power supply for the relays, rather than to branch off from the power supply of the receiver.



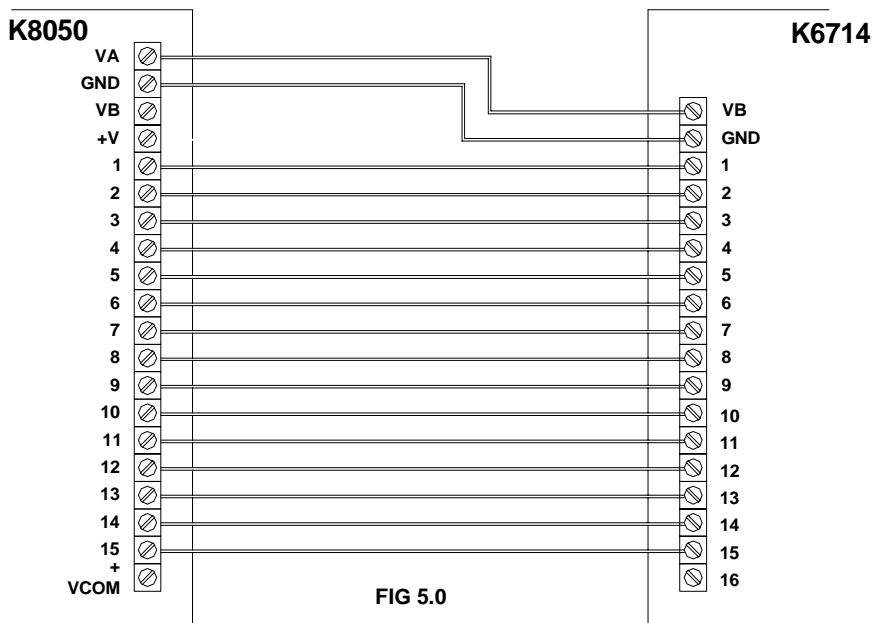
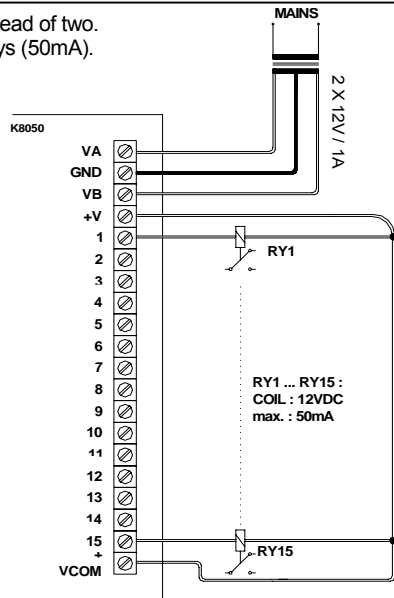
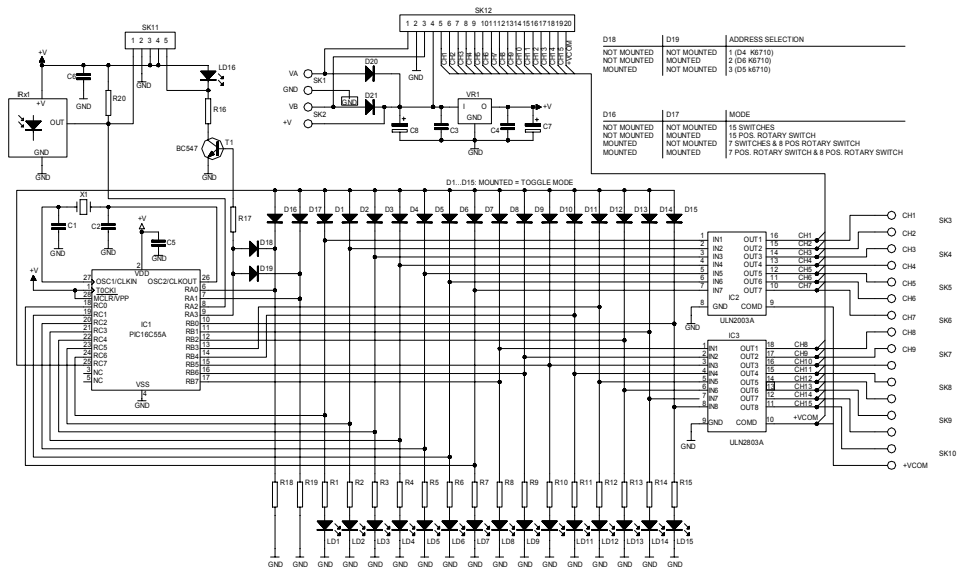

Fig 6.0 is the connection diagram for using just one transformer instead of two. Take care not to exceed the maximum current of the individual relays (50mA).



18. Schematic diagram.



19. PCB

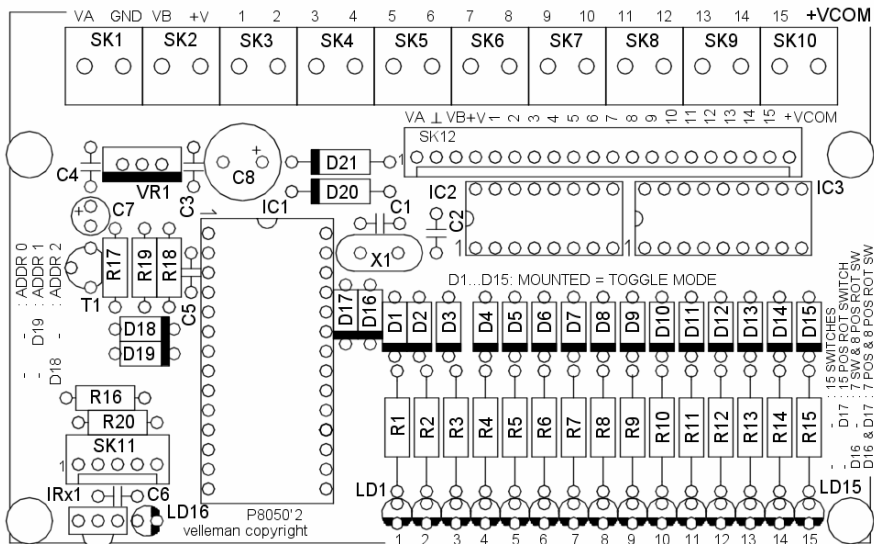



Modifications and typographical errors reserved
© Velleman Components nv.
H8050IP - 2004 - ED1 (rev. 1.0)

