



Extended USB interface card

A practically useful 33I/O universal USB interface board.

Total solder points: 578

Difficulty level: *beginner* 2 3 4 5 *advanced*

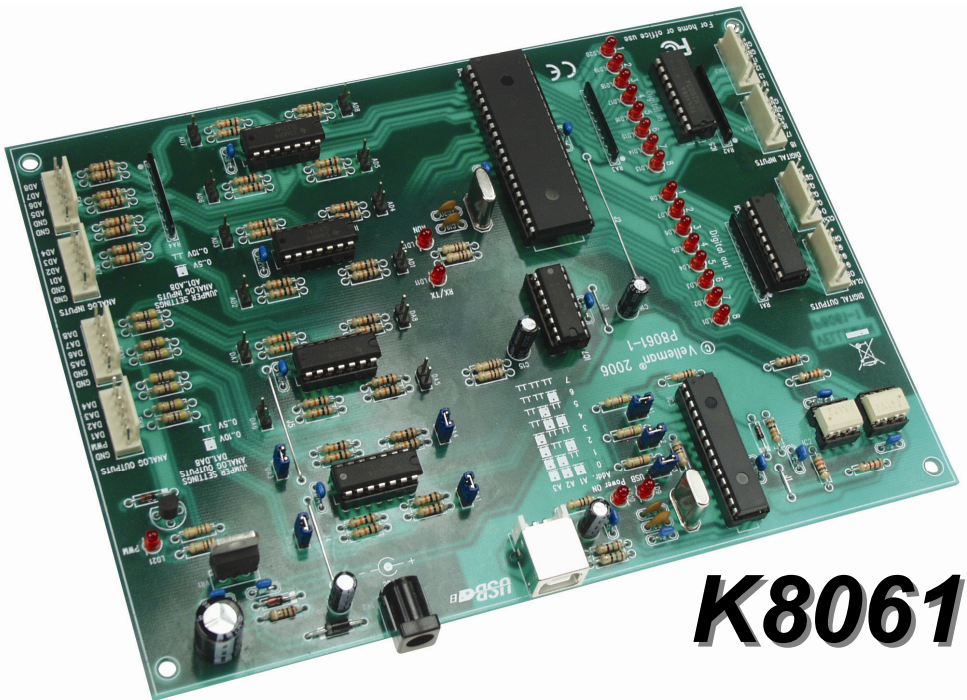

K8061

This interface board has a total of 33 input/outputs: including analogue / digital and + 1PWM output.

Connection to the computer is galvanically-optically isolated, so that damage to the computer is not possible thus providing a high level of secure implementation.

All communication routines are contained in a Dynamic Link Library (DLL).

You may write custom Windows*. Applications in Delphi, Visual Basic, C++ Builder or most other 32-bit Windows application development tool that supports calls to a DLL.

For a first introduction to interfacing and instructions, please refer to our K8055 experiment interface board.

Features:

- 8 analogue 10 bit resolution inputs: 0...5 or 10VDC / 20kohm
- 8 analogue 8 bit resolution outputs: 0...5V or 10VDC / 47ohm
- 8 digital inputs: open collector compatible (connection to GND=0) with on board LED indication
- 8 digital open collector outputs (max. 50V/100mA) with on board LED indication
- one 10 bit PWM output: 0 to 100% open collector output (max 100mA / 40V) with on board LED indication.
- general response time: 4ms per command
- USB Port: 2.0 and 1.1 compatible (USB cable included)

Specifications:

- power consumption through USB port : approx. 60mA
- up to 8 cards can be connected to PC
- power supply through adaptor : 12Vdc / 300 mA ([PS1205](#))
- PCB Dimensions : 195 x 142 x 20mm (2.7 " x 5.6" x 0.8")

Minimum system:

- pentium class CPU with free USB port (1.1 or higher)
- windows 98SE or higher (Win NT excluded) *
- CD ROM player and Mouse

* WinXp recommended for optimum compatibility

* Are registered trademarks of MICROSOFT CORP.

1. Assembly (Skipping this can lead to troubles !)

Ok, so we have your attention. These hints will help you to make this project successful. Read them carefully.

1.1 Make sure you have the right tools:

- A good quality soldering iron (25-40W) with a small tip.
- Wipe it often on a wet sponge or cloth, to keep it clean; then apply solder to the tip, to give it a wet look. This is called 'thinning' and will protect the tip, and enables you to make good connections. When solder rolls off the tip, it needs cleaning.
- Thin raisin-core solder. Do not use any flux or grease.
- A diagonal cutter to trim excess wires. To avoid injury when cutting excess hold the lead so they cannot fly towards the eyes.
- Needle nose pliers, for bending leads, or to hold components in place.
- Small blade and Phillips screwdrivers. A basic range is fine.

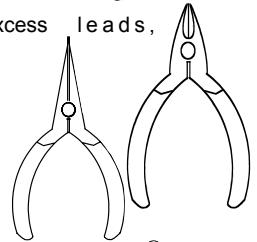
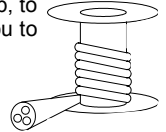
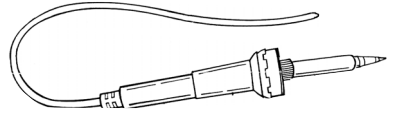

leads,



For some projects, a basic multi-meter is required, or might be handy

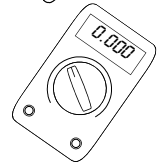

1.2 Assembly Hints :

- ⇒ Make sure the skill level matches your experience, to avoid disappointments.
 - ⇒ Follow the instructions carefully. Read and understand the entire step before you perform each operation.
 - ⇒ Perform the assembly in the correct order as stated in this manual
 - ⇒ Position all parts on the PCB (Printed Circuit Board) as shown on the drawings.
 - ⇒ Values on the circuit diagram are subject to changes.
 - ⇒ Values in this assembly guide are correct*
 - ⇒ Use the check-boxes to mark your progress.
 - ⇒ Please read the included information on safety and customer service
- ⇒ * Typographical inaccuracies excluded. Always look for possible last minute manual updates, indicated as 'NOTE' on a separate leaflet.

1.3 Soldering Hints :

1- Mount the component against the PCB surface and carefully solder the leads

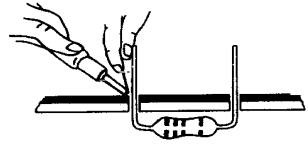

2- Make sure the solder joints are cone-shaped and shiny

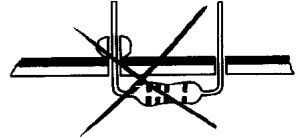
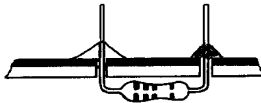

3- Trim excess leads as close as possible to the solder joint

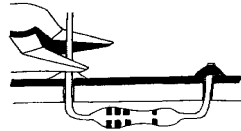

REMOVE THEM FROM THE TAPE ONE AT A TIME !

AXIAL COMPONENTS ARE TAPED IN THE CORRECT MOUNTING SEQUENCE !

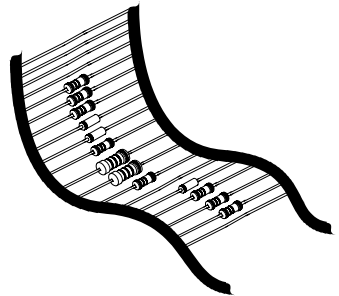

1. Jumpers

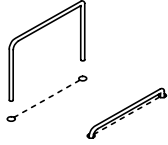

- J1
- J2
- J3
- J4
- J5

2. Diodes. Watch the polarity!

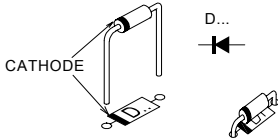

- D1 : 1N4007
- D2 : 1N4148
- D3 : 1N4148

3. 1/4W Resistors

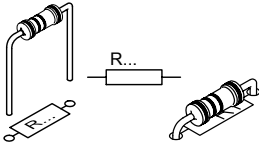

- R1 : 2K2 (2-2-2-B)
- R2 : 15E (1-5-0-B)
- R3 : 15E (1-5-0-B)

4. Metal film resistors

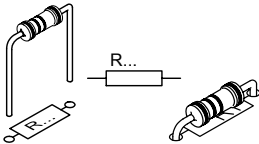

- R4 : 100E (1-0-1-B-9)

5. 1/4W Resistors

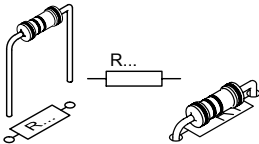

- R5 : 330E (3-3-1-B)
- R6 : 1K (1-0-2-B)
- R7 : 1K (1-0-2-B)
- R8 : 10K (1-0-3-B)
- R9 : 47K (4-7-3-B)

- R10 : 10K (1-0-3-B)
- R11 : 10K (1-0-3-B)
- R12 : 10K (1-0-3-B)
- R13 : 10K (1-0-3-B)
- R14 : 1K (1-0-2-B)
- R15 : 330E (3-3-1-B)
- R16 : 2K2 (2-2-2-B)
- R17 : 47K (4-7-3-B)
- R18 : 47K (4-7-3-B)
- R19 : 1K5 (1-5-2-B)
- R20 : 1K (1-0-2-B)
- R21 : 10K (1-0-3-B)
- R22 : 10K (1-0-3-B)
- R23 : 10K (1-0-3-B)
- R24 : 10K (1-0-3-B)
- R25 : 1K (1-0-2-B)
- R26 : 1K (1-0-2-B)
- R27 : 10K (1-0-3-B)
- R28 : 10K (1-0-3-B)
- R29 : 10K (1-0-3-B)
- R30 : 10K (1-0-3-B)
- R31 : 47E (4-7-0-B)
- R32 : 47E (4-7-0-B)
- R33 : 47E (4-7-0-B)
- R34 : 10K (1-0-3-B)
- R35 : 10K (1-0-3-B)
- R36 : 10K (1-0-3-B)
- R37 : 10K (1-0-3-B)
- R38 : 47E (4-7-0-B)
- R39 : 47E (4-7-0-B)
- R40 : 47E (4-7-0-B)
- R41 : 1K (1-0-2-B)
- R42 : 1K (1-0-2-B)
- R43 : 10K (1-0-3-B)
- R44 : 10K (1-0-3-B)
- R45 : 10K (1-0-3-B)
- R46 : 10K (1-0-3-B)
- R47 : 47E (4-7-0-B)
- R48 : 47E (4-7-0-B)
- R49 : 10K (1-0-3-B)
- R50 : 10K (1-0-3-B)
- R51 : 10K (1-0-3-B)
- R52 : 10K (1-0-3-B)
- R53 : 10K (1-0-3-B)
- R54 : 10K (1-0-3-B)
- R55 : 10K (1-0-3-B)
- R56 : 10K (1-0-3-B)
- R57 : 10K (1-0-3-B)
- R58 : 10K (1-0-3-B)
- R59 : 10K (1-0-3-B)
- R60 : 10K (1-0-3-B)
- R61 : 10K (1-0-3-B)
- R62 : 10K (1-0-3-B)
- R63 : 10K (1-0-3-B)
- R64 : 10K (1-0-3-B)
- R65 : 10K (1-0-3-B)
- R66 : 10K (1-0-3-B)
- R67 : 10K (1-0-3-B)
- R68 : 10K (1-0-3-B)

6. Zenerdiode. Watch the polarity!

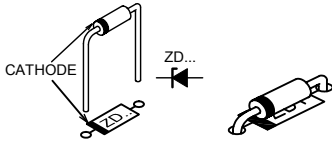

- ZD1 : 15V0

7. Resistor array.

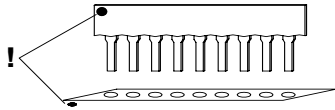

- RA1 : 1K (102)
- RA2 : 10K (103)
- RA3 : 1K (102)
- RA4 : 10K (103)

👉 Watch the position of the dot.

8. Ceramic Capacitors

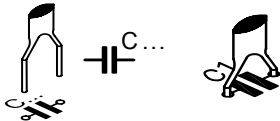

- C1 : 220nF (224)
- C2 : 27pF (27)
- C4 : 100nF (104)
- C5 : 100nF (104)
- C6 : 100nF (104)
- C7 : 27pF (27)
- C8 : 100nF (104)
- C11 : 100nF (104)
- C12 : 100nF (104)
- C13 : 100nF (104)
- C14 : 100nF (104)
- C17 : 100nF (104)
- C18 : 100nf (104)
- C19 : 27pF (27)
- C20 : 27pF (27)
- C21 : 100nF (104)
- C22 : 100nF (104)
- C23 : 100nF (104)
- C24 : 100nF (104)

9. IC sockets. Watch the position of the notch!

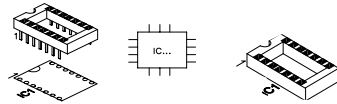

- IC1 : 8p
- IC2 : 8p
- IC3 : 28p
- IC4 : 18p
- IC5 : 18p
- IC6 : 40p
- IC7 : 16p
- IC8 : 14p
- IC9 : 14p
- IC10 : 14p
- IC11 : 14p

10. LEDs. Watch the polarity!

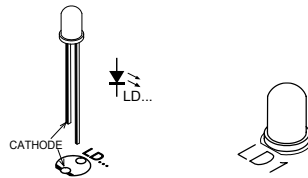

- LD1 : Digital output 8
- LD2 : Digital output 7
- LD3 : Digital output 6
- LD4 : Digital output 5
- LD5 : Digital output 4
- LD6 : Digital output 3
- LD7 : Digital output 2
- LD8 : Digital output 1
- LD9 : USB
- LD10 : Power ON
- LD11 : RX/TX
- LD12 : Run
- LD13 : Digital input 8
- LD14 : Digital input 7
- LD15 : Digital input 6
- LD16 : Digital input 5
- LD17 : Digital input 4
- LD18 : Digital input 3
- LD19 : Digital input 2
- LD20 : Digital input 1
- LD21 : PWM

11. Transistor.

- T1 : BC337
-

12. Pin headers

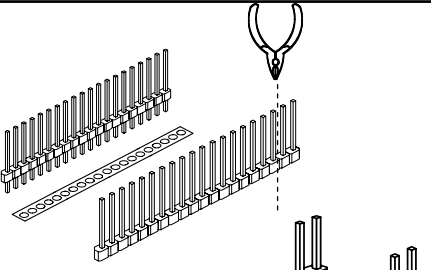

- A1
- A2
- A3

} Card adress

- AD1
- AD2
- AD3
- AD4
- AD5
- AD6
- AD7
- AD8

} Analog inputs

- DA1
- DA2
- DA3
- DA4
- DA5
- DA6
- DA7
- DA8

} Analog outputs

13. Electrolytic capacitors. Watch the polarity!

- C9 : 4,7 μ F / 50V
- C10 : 47 μ F / 25V
- C15 : 4,7 μ F / 50V
- C16 : 4,7 μ F / 50V

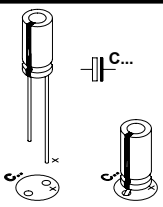

14. Quartz Crystal

- X1 : 4MHz
- X2 : 16MHz

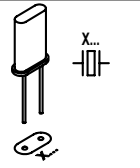

15. Electrolytic capacitor. Watch the polarity!

- C3 : 470 μ F / 25V

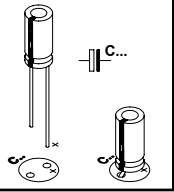

16. DC-jack

- SK2 : 12VDC

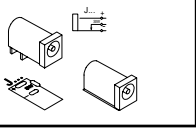

17. USB connector

- SK1

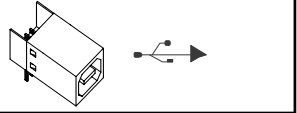

18. Voltage regulator

- VR1 : UA7805

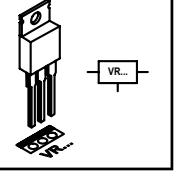

19. Shunts

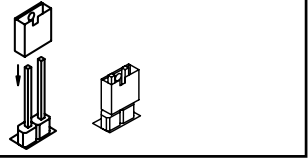

20. Board to wire connectors

- SK3 : digital input 1 ... 4
- SK4 : digital input 5 ... 8
- SK5 : digital output 1 ... 4
- SK6 : digital output 5 ... 8
- SK7 : analog input 1 ... 4
- SK8 : analog input 5 ... 8
- SK9 : analog output 1 ... 4
- SK10 : analog output 5 ... 8

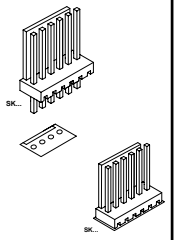

21. IC's. Watch the position of the notch!

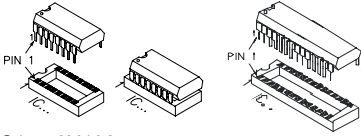

- IC1 : 6N136
- IC2 : 6N136
- IC3 : VK8061USB (programmed PIC18F2550-I/SP)
- IC4 : ULN2803
- IC5 : ULN2803
- IC6 : VK8061CPU (programmed PIC16F871-I/P)
- IC7 : TLC5628CN
- IC8 : TLV274IN
- IC9 : TLV274IN
- IC10 : TLV274IN
- IC11 : TLV274IN

22. Rubber feet

Mount the rubber feet on the solder side of the PCB, see fig 1.0.

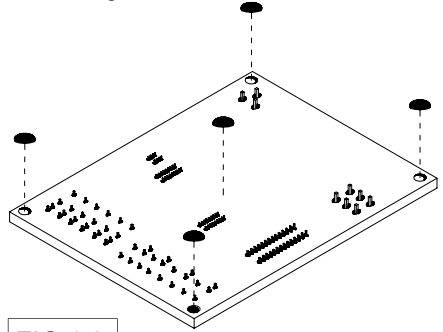
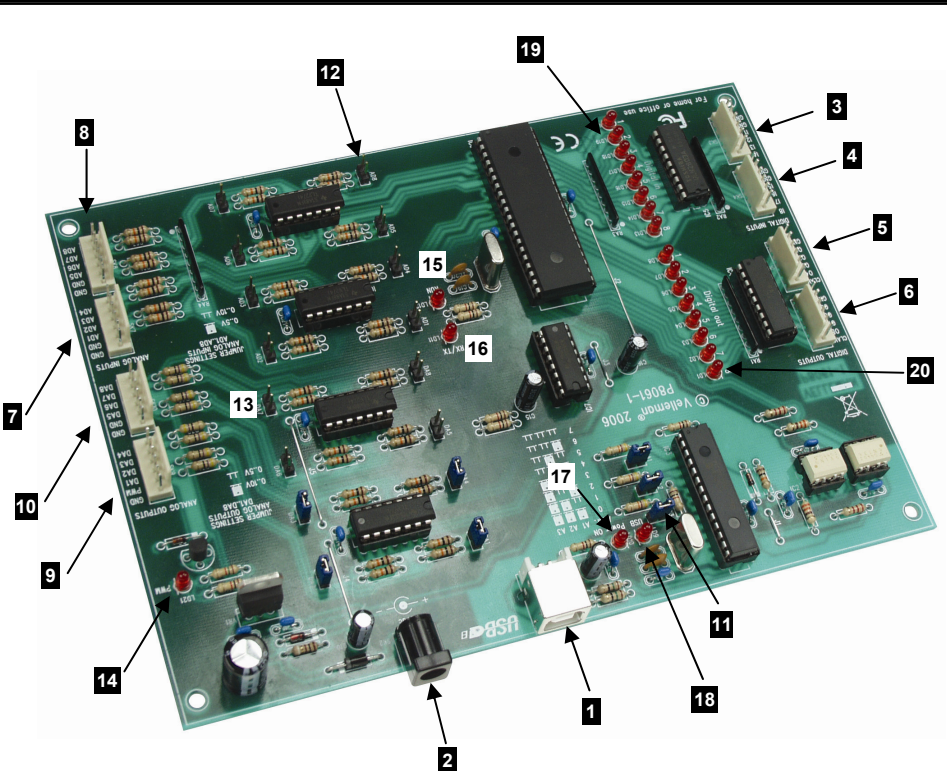

FIG 1.0

23. Connection points



1	USB-connector	Connection of the K8061 with the USB port of your PC
2	12VDC	Power supply connection. Connect a 12V non-regulated adapter supplying min. 300mA
3	Digital inputs 1, 2, 3, 4	Inputs need to go "LOW" externally to activate (connect with the GND).
4	Digital inputs 5, 6, 7, 8	
5	Digital outputs 1, 2, 3, 4	These outputs are open collector outputs. When active, the transistors in IC4 will conduct and a "connection" will be established between GND and the output in question. The charge you wish to feed, like a LED, relay ..., must receive an external tension. Connect the "CLAMP" connection with the + of this external power supply so as to protect the transistor array.
6	Digital outputs 5,6,7,8	
7	Analogue inputs 1,2,3,4	These are measuring points with which you can digitalize and read out an analogue voltage through the PC. The analogue inputs expect a DC voltage between 0 and 5V or between 0 and 10V. Select with the jumpers AD1 to AD8 (see n° 13). Attention: Supplying a voltage to the A/D inputs higher than 5 or 10V can cause irrevocable damage to the K8061 (IC10/11)!
8	Analogue inputs 5,6,7,8	
9	Analogue outputs 1,2,3,4	Determination with software of the DC voltage on these outputs. Depending on the jumpers DA1 to DA8 you can establish this voltage between 0 and 5V or between 0 and 10V. On pin 2 of this connector (SK9) you can also find the PWM output. The PWM output is an open collector output whose pulse width is adjustable.
10	Analogue outputs 5,6,7,8	
11	Addressing of the selection jumpers	With the jumpers A1, A2 and A3 you can attribute a unique address to each connected K8061. Up to 8 boards can be connected. If you have only 1 K8061, establish its address as "0".
12	Max. A/D voltage	With the jumpers AD1-AD8 you can select the voltage range for the corresponding A/D inputs between 0 to 5V (closed) or 0 to 10V (open).
13	Max. D/A output voltage	With the jumpers DA1-DA8 you can select the max. voltage range for the corresponding D/A outputs between 0 to 5V (open) or 0 to 10V (closed)
14	PWM control LED	This LED will light if the PWM output is active. The brightness of the LED is analogous to the pulse/pause relation.
15	CPU "run mode" LED	Lights when the CPU of the K8061 (IC6) is functioning correctly.
16	CPU RC/TX LED	This LED lights in case of data exchange between the CPU and the USB interface controller (IC3). If the LED does not light when the board is powered, check the USB controller (IC3) or the optical separation (IC1 & 2) for faults.
17	"POWER ON" LED	Lights in case of the presence of the 5V power supply for the USB controller. Attention: The K8061 is powered through the USB port of your PC and does not guarantee operation of the power supply section of the K8061's CPU and I/O section.
18	"USB" LED	Blinks during USB connection and lights at every successful connection between the USB chip in your PC and the K8061.
19	Digital input indication	These LEDs turn out when a corresponding input goes "LOW" (connection of the input with GND) through an external contact or an external open collector input.
20	Digital output indication	These LEDs light if a corresponding output is active, i.e. when a connection is established between an output pin and GND (open collector output).

24. Software installation

After assembly of the circuit, it is now time to install the software drivers and examples and to test the K8061.

- Connect a 12V power supply (non regulated 12V adapter) to the power supply connector of the K8061 (SK2).
- The control LED LD12 (RUN) should light as well as LD13 to LD20 (these are the input control LEDs and light when the inputs are not active "LOW").

If **OK**, connect the USB connector of the K8061 to your PC using the included USB cable.

- LD10 (POWER) should light.
- LD9 (USB) should light next in case of a data connection between the PC and the K8061.
- With the first connection, you should install the USB driver of the microcontroller onto the PC first. The location of this driver can be found on the included CD in the 'USB_driver' subfolder of the K8061 software.

Refer to the figures below illustrating the driver installation (example Windows XP):



Screenshots may vary with different operating system

Step 1 : New hardware detected

Local driver, don't run Windows Update



Step 2 : Select "specific location"

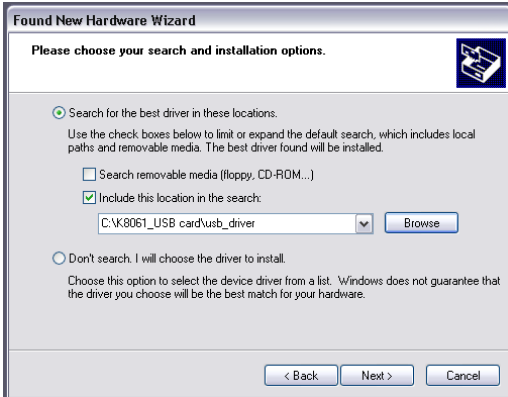

Step 3 : Browse through the driver folder on your hard disk or included CD.

Select driver : **mchpusb.sys**

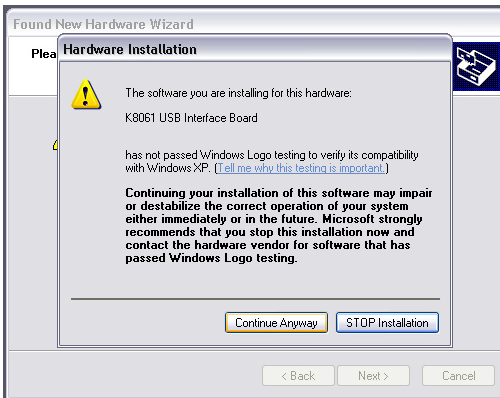

Step 4 : Click "Continue Anyway"



Step 5 : Click "Finish"

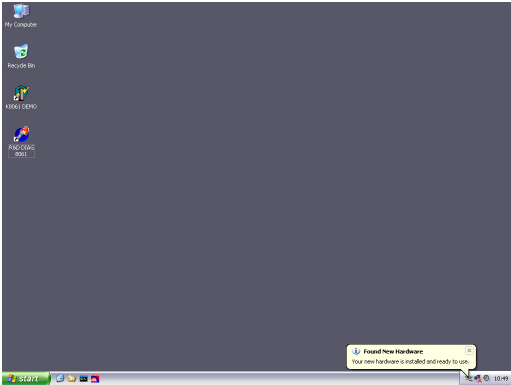

Installation is successful

- A utility to check the operation of the K8061 can be found in the “DIAG8061” subfolder.

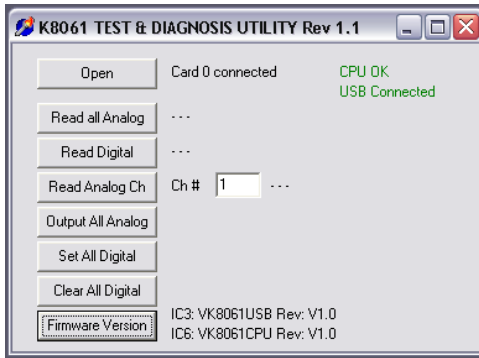

- A more elaborate test application can be found in the “DEMO8061” subfolder. The source code of the test application can be found in the “DLL examples” subfolder. Explanation concerning the communication DLL of the K8061 can be found in the “DOC” subfolder.

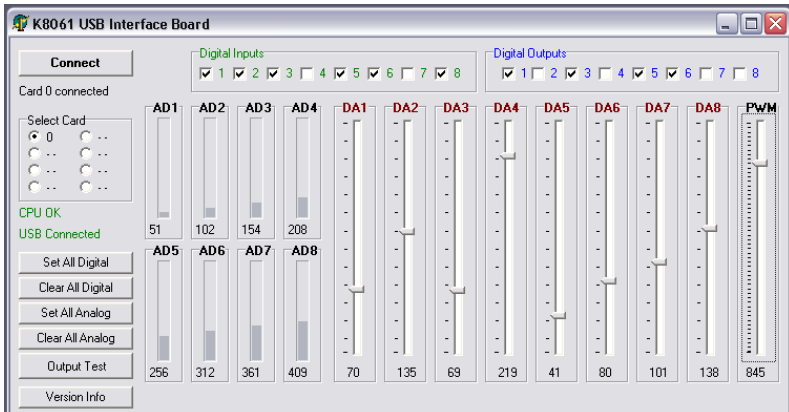

25. How to connect :

1. Analog output :

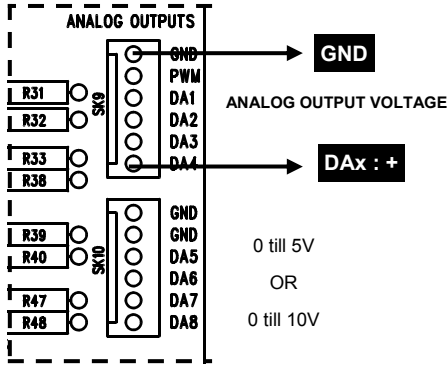

2. Analog input :

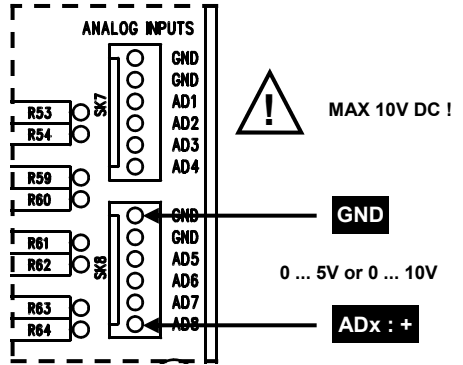

3. Digital output :

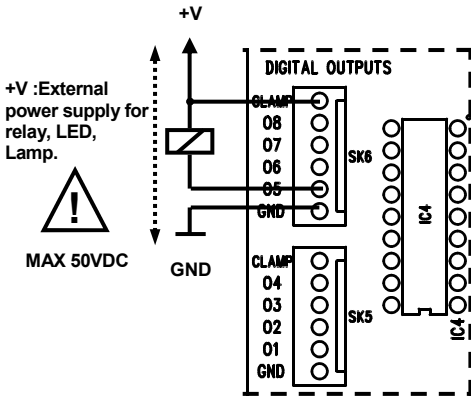

4. Digital input :

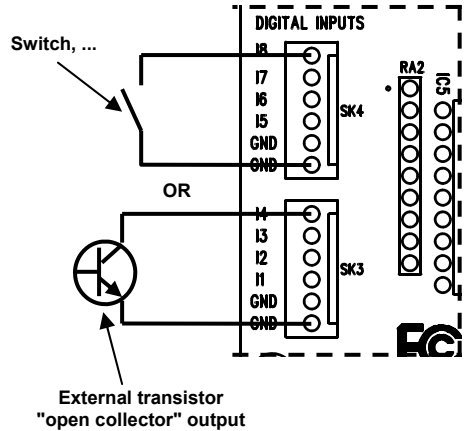

26. Schematic diagram

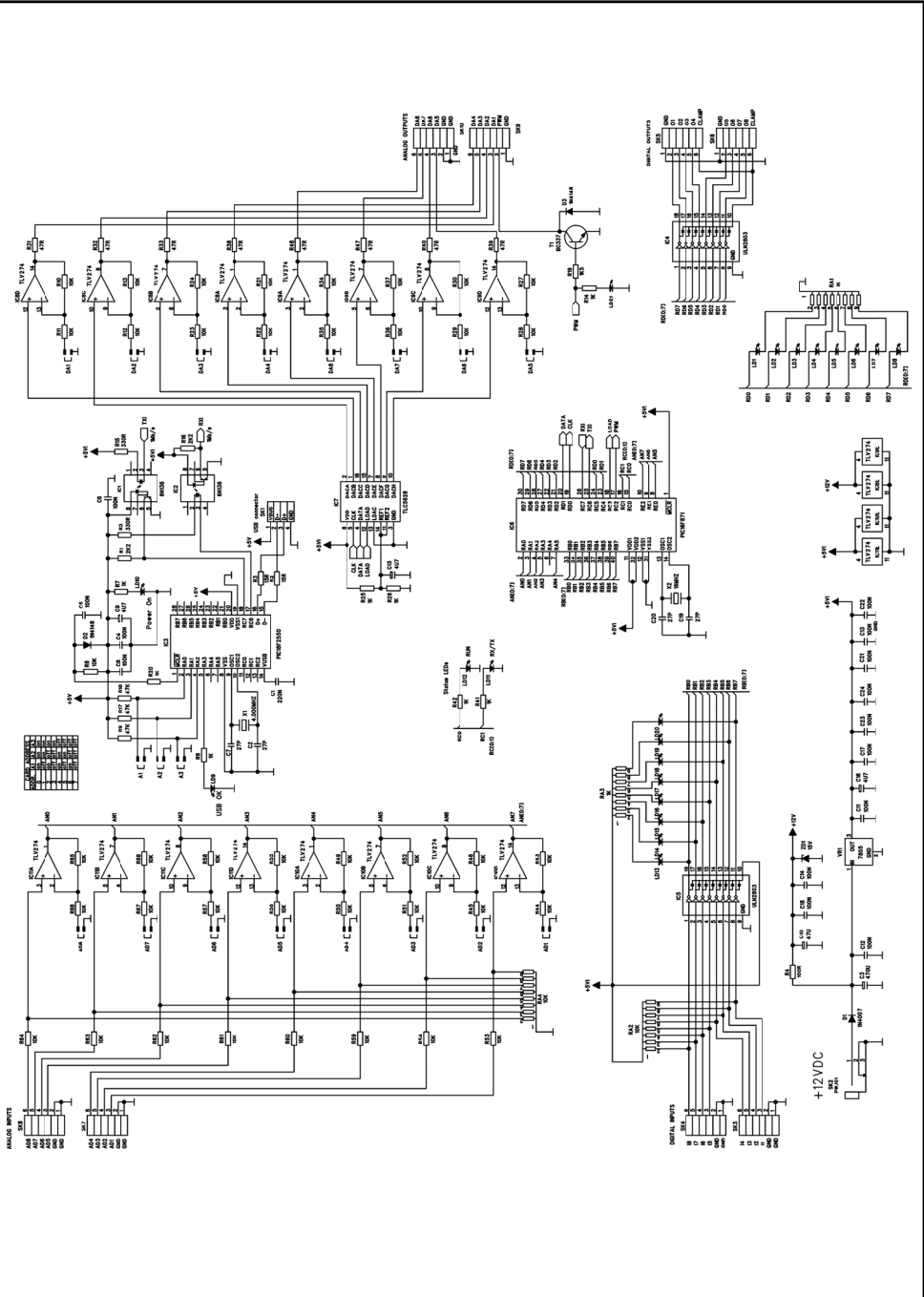

27. PCB layout.

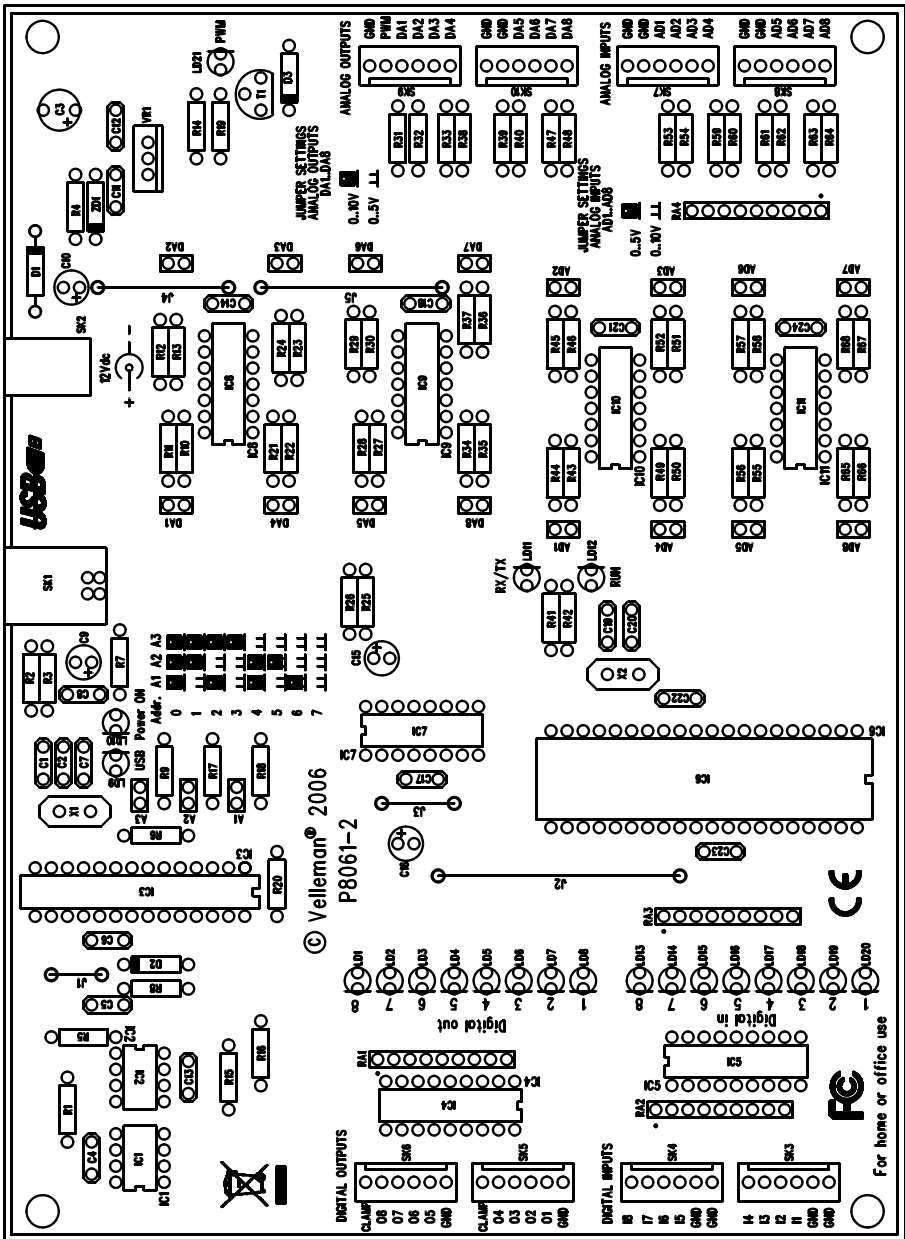



VELLEMAN COMPONENTS
Legen Heirweg 33
9890 Gavere
Belgium Europe
Info ? : <http://www.velleman.be>

Modifications and typographical errors reserved
© Velleman Kit nv
H8061IP - 2006 - ED1 (rev. 1.0)

