

Total solder points: 77
Difficulty level: beginner 1 2 3 4 5 advanced

OPTICAL PROXIMITY SWITCH

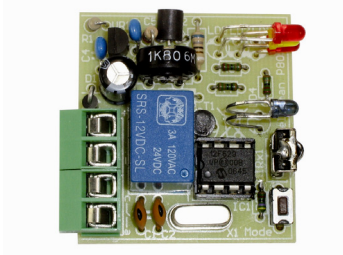

K8092

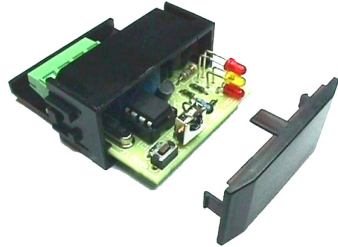

Operate by waving hand or object in front of unit

Features:

- small and compact unit
- operate output relay by waving hand or object in front of unit
- no touching required
- adjustable sensitivity
- status led indicators
- momentary (pulse) or toggle (ON/OFF) mode
- Perfectly suited for our Velbus system and our K8006 home bus system
- Use for detection in DIY projects (not suited for very dark object detection)
- Comes complete with snap-in enclosure. Type VMBFBI
- fits Velleman VMBFDG and VMBFLG frames

Specifications:

- power supply: max. 12VDC/100mA
- output relay rating: 3A/24VDC
- LED indication
- dimensions (wxhxd): 21x47x41mm / 0.8x1.85x1.6"

1. Assembly (Skipping this can lead to troubles !)

Ok, so we have your attention. These hints will help you to make this project successful. Read them carefully.

1.1 Make sure you have the right tools:

- A good quality soldering iron (25-40W) with a small tip.
- Wipe it often on a wet sponge or cloth, to keep it clean; then apply solder to the tip, to give it a wet look. This is called 'thinning' and will protect the tip, and enables you to make good connections. When solder rolls off the tip, it needs cleaning.
- Thin rosin-core solder. Do not use any flux or grease.
- A diagonal cutter to trim excess wires. To avoid injury when cutting excess leads, hold the lead so they cannot fly towards the eyes.
- Needle nose pliers, for bending leads, or to hold components in place.
- Small blade and Phillips screwdrivers. A basic range is fine.

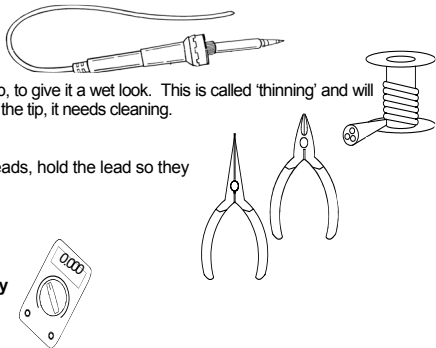

For some projects, a basic multi-meter is required, or might be handy

1.2 Assembly Hints :

- ⇒ Make sure the skill level matches your experience, to avoid disappointments.
- ⇒ Follow the instructions carefully. Read and understand the entire step before you perform each operation.
- ⇒ Perform the assembly in the correct order as stated in this manual
- ⇒ Position all parts on the PCB (Printed Circuit Board) as shown on the drawings.
- ⇒ Values on the circuit diagram are subject to changes.
- ⇒ Values in this assembly guide are correct*
- ⇒ Use the check-boxes to mark your progress.
- ⇒ Please read the included information on safety and customer service

* Typographical inaccuracies excluded. Always look for possible last minute manual updates, indicated as 'NOTE' on a separate leaflet.

1.3 Soldering Hints :

1- Mount the component against the PCB surface and carefully solder the leads

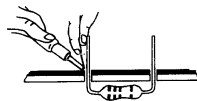

2- Make sure the solder joints are cone-shaped and shiny

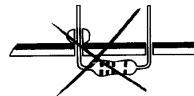
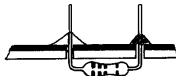

3- Trim excess leads as close as possible to the solder joint

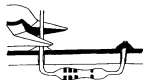

REMOVE THEM FROM THE TAPE ONE AT A TIME !

**AXIAL COMPONENTS ARE TAPED IN THE
CORRECT MOUNTING SEQUENCE !**

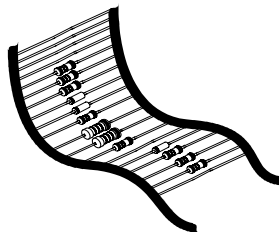

1. Diode. Watch the polarity!

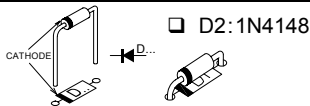

2. Resistors

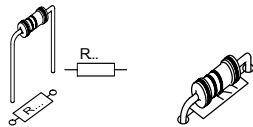

1/8W:

- R3 : 33K (3 - 3 - 3 - B)
- R4 : 2K2 (2 - 2 - 2 - B)
- R5 : 2K2 (2 - 2 - 2 - B)
- R7 : 2K2 (2 - 2 - 2 - B)
- R8 : 220 (2 - 2 - 1 - B)

Metalfilm 1/2W:

- R2 : 68 (6 - 8 - 0 - B - 9)

3. Crystal.

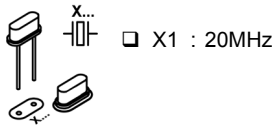

4. Push button

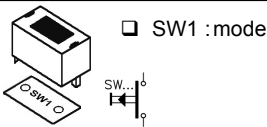

5. LED. Watch the polarity!

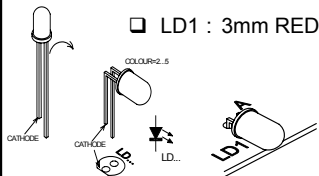

6. IC socket. Watch the position of the notch!

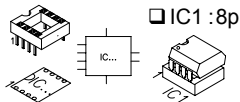

7. Capacitors.

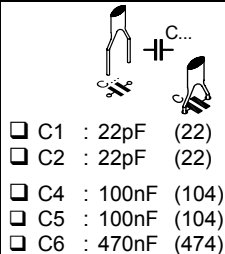

8. Transistors

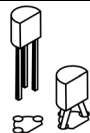

□ T1 : BC547B

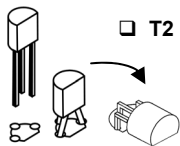

□ T2 : BC337

☞ Make sure that transistor T2 is bent towards the PCB.

9. Voltage regulator

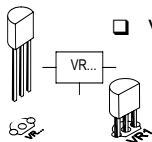

□ VR1 : UA78L05

10. LED. Watch the polarity!

□ LD2 : 3mm (Yellow)

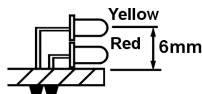

11. Infrared diode. Watch the polarity!

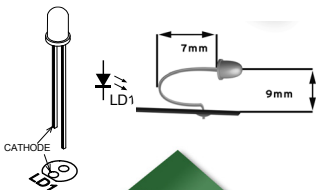

□ LD4 : 3mm infrared diode (blue)

Spacer

12. Diode. Watch the polarity!



□ D1 : 1N4007

13. Vertical resistor (metal film)

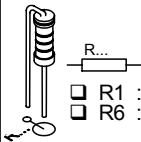

□ R1 : 100 (1-0-1-B-9)
 □ R6 : 22 (2-2-0-B-9)

14. IR - demodulator

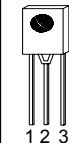

□ IRX1 : 38KHz/600µs

15. Electrolytic Capacitor. Watch the polarity !

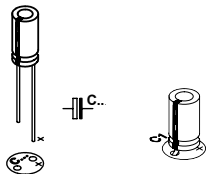

□ C3 : 100 μ F / 25V

16. Trimmer

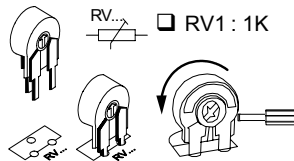

□ RV1 : 1K

17. Relay

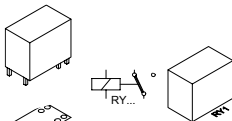

□ RY1

18. Terminal block

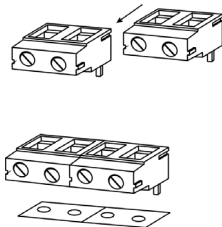

□ SK1 : 2p 'power supply'
□ SK2 : 2p 'output relay'

19. LED. Watch the polarity!

□ LD3 : 3mm (red)

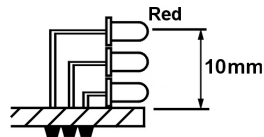

Mount LD3 if used with Velbus VMB8PB.

20. IC. Watch the position of the notch!

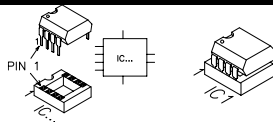

□ IC1 : VK8092
(programmed PIC12F629)

Connection

Stand alone

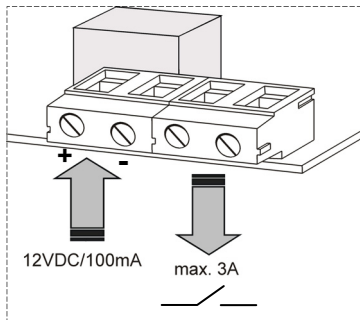

DO NOT MOUNT LD3

With velbus system

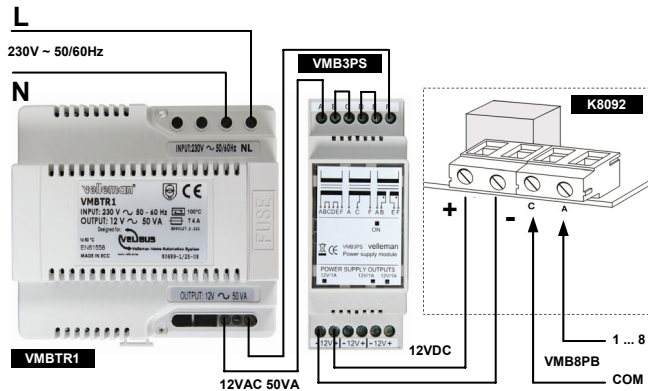

MOUNT LD3 IF USED WITH VELBUS VMB8PB.

Mounting in enclosure VMBFBI

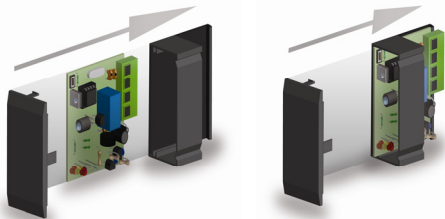
A

Slide the PCB into the slot of the housing. Make sure that the connection side of the kit is slid in first.

B

Click the cover of the housing onto the enclosure

Control

The relay is in pulse mode by default. LD2 will flash once to visually confirm you the mode and operation.

When toggle mode is desired follow these steps to change the relay mode:

1. Hold push button SW1 pressed when power is disconnected.
2. Connect the power but keep push button SW1 pressed. LD2 will confirm by blinking twice. Release button.

Repeat this function if you want to change the mode from toggle to pulse mode.

Turn trimmer RV1 to the right to increase the infrared remote sensitivity; turn to the left to decrease the sensitivity.

Schematic diagram.

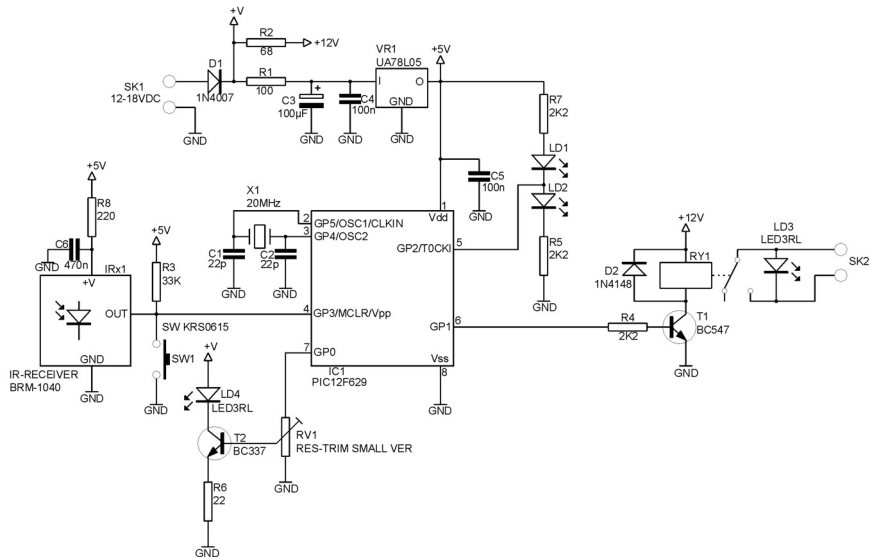

PCB

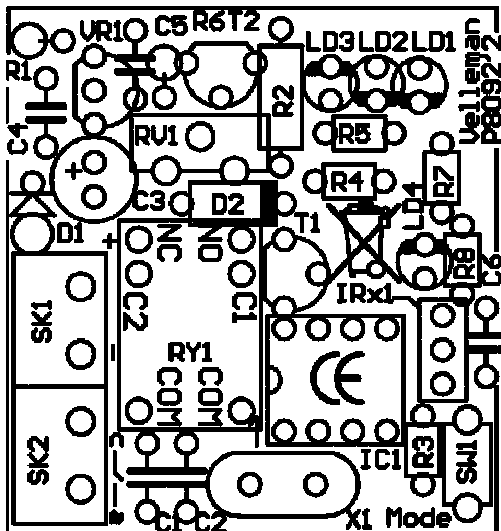

VELBUS
Velleman Home Automation System

VELBUS
Velleman Home Automation System

**All appliances get intelligent, how about your home?
see our website : www.velbus.be**

Modifications and typographical errors reserved
 © Velleman nv.
 H8092IP'1 - 2009 (version2)

VELLEMAN NV
Legen Heirweg 33, 9890 Gavere
Belgium - Europe

