

VMA02

MANUALE UTENTE HVMA02'1

Shield audio per Arduino®

velleman®
MODULES

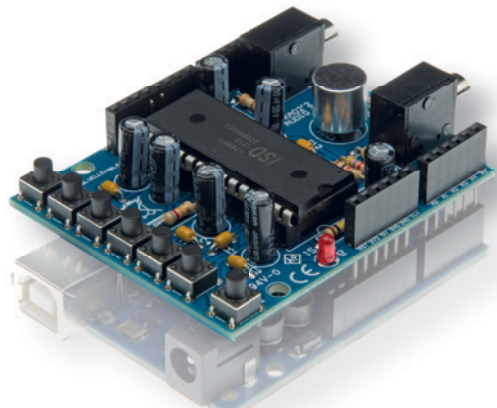

Registra la tua voce utilizzando il microfono integrato o l'apposito ingresso audio.

Caratteristiche

- Compatibile con Arduino Due™, Arduino Uno™, Arduino Mega™
- Basato sul chip ISD1760PY
- Completo di pulsanti REC, PLAY, FWD, ERASE, VOL, RESET e FEEDTROUGH
- Microfono integrato
- Presa jacks 3,5mm stereo per LINE IN e OUT
- Uscita speaker

Specifiche

- Tempo di registrazione: 60s
- Alimentazione: da board Arduino™
- Dimensioni: 71 x 53mm / 2,79 x 2,08"





Partecipa al nostro forum Velleman Projects

1 PULSANTI



2 SPEAKER
4 - 8 ohm



JACK STEREO 3,5 mm

3 LINE OUT



4 CONNETTORE ICSP

5 MICROFONO

6 LINE IN



7 INDICATORE DI FUNZIONAMENTO

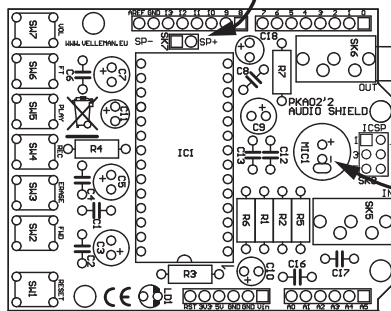

SCARICA LO SKETCH D'ESEMPIO DALLA SCHEDA DEL PRODOTTO VMA02 DISPONIBILE SU WWW.VELLEMAN.BE

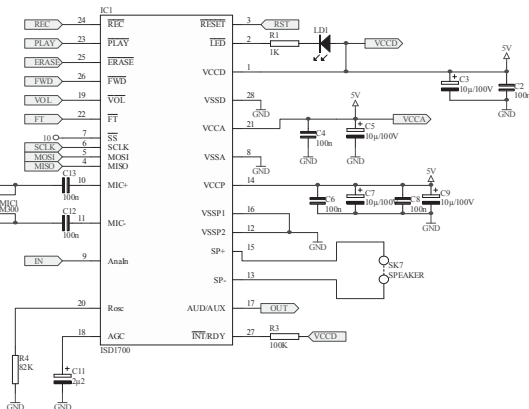
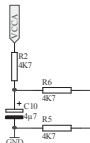
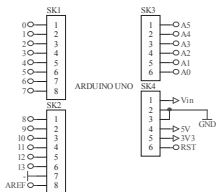
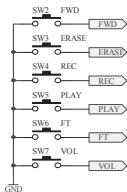
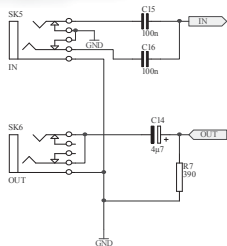



È disponibile il nuovo catalogo
Velleman Projects. Scarica la tua copia da:
www.vellemanprojects.eu



Soggetto a modifiche senza preavviso. Non siamo responsabili di eventuali
errori tipografici o di altra natura - © Velleman nv. HVMA02 Velleman NV,
Legen Heirweg 33 - 9890 Gavere.