

MICROCONTROLLER

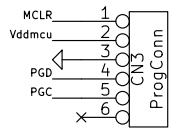

SDA _____ SDAbb
SCL _____ SCLbb

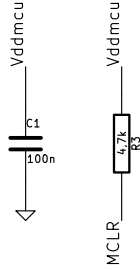
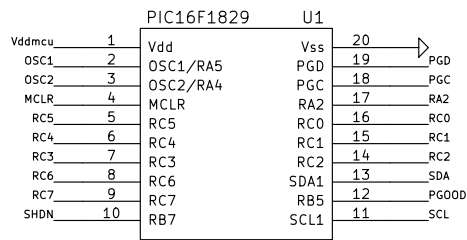
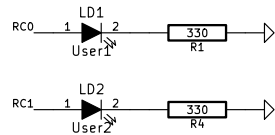
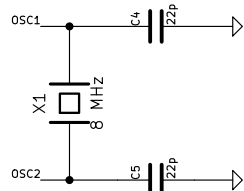

SENSOR CONNECTOR

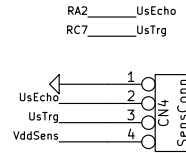

DIP-SWITCHES

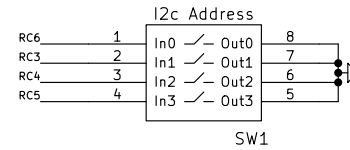

INTERRUPT SIGNAL

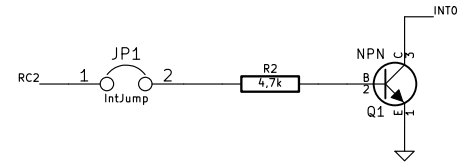

CHARGE PUMP

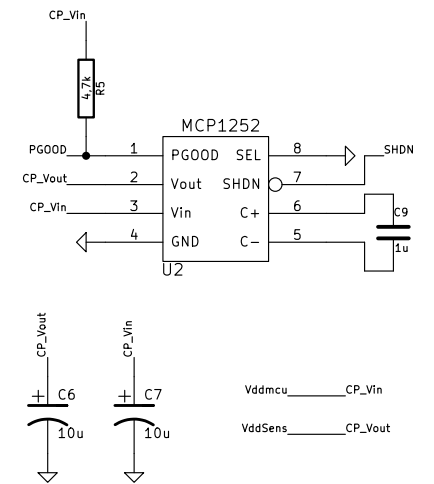

APP CONNECTORS

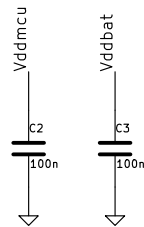
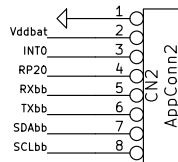
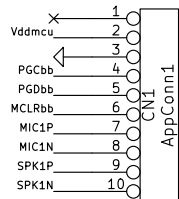

| | | |
|---|-------------------|----------|
| Francesco Ficili | | |
| File: Mercury.sch | | |
| Sheet: / | | |
| Title: IoT Board Mercury – Ultrasonic Board | | |
| Size: A4 | Date: 20 mar 2018 | Rev: 1.0 |
| KiCad E.D.A. | | Id: 1/1 |