

Relè miniatura 5 Vdc - 3A

Prezzo: 0.82 €

Tasse: 0.18 €

Prezzo totale (con tasse): 1.00 €

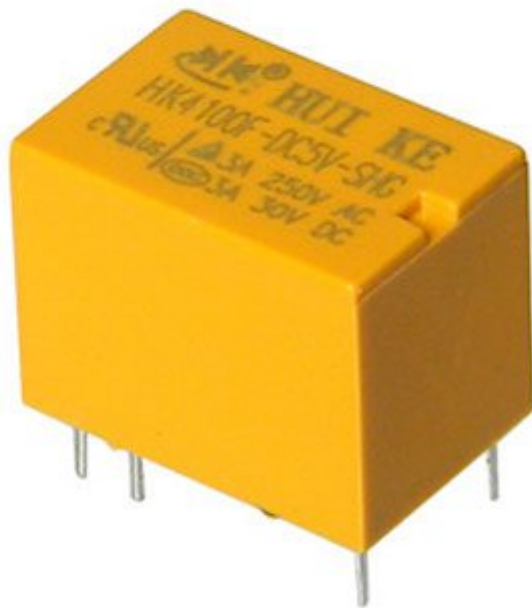

Relè sigillato con terminali da circuito stampato. È caratterizzato da dimensioni estremamente compatte (15,5x10,5x11,6 mm), da una elevata sensibilità ed affidabilità. Alimentazione bobina: 5 VDC / 13 mA, portata contatti: 3 A - 30 VDC / 220 VAC.

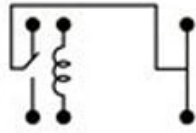
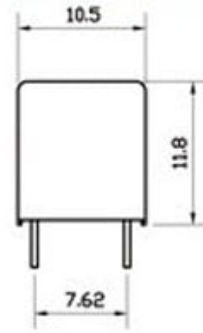
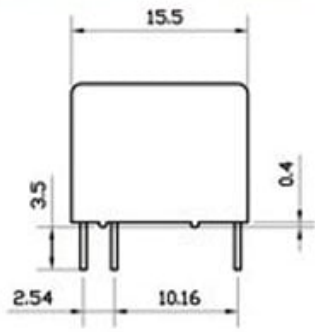

BOTTOM VIEW
(1C)

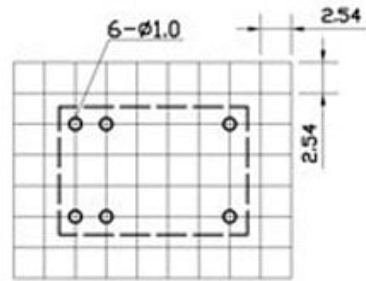

BOTTOM VIEW
(1C)